



DICOM 3.0 Conformance Statement



Aixplorer® Ultrasound System

Revision: 02
Date: July 05, 2012

Doc Ref: SSID02516-02
Software Version: V6

Chapter 1

Conformance Statement Overview

Aixplorer implements the necessary DICOM services to:

- Support the Echo (Verification) service as both SCU/SCP;
- Support Modality Worklist Service as SCU;
- Support Modality Performed Procedure Step Service as SCU;
- Support Basic Printing Service as SCU;
- Support Query/Retrieve Service as SCU;
- Support Image Storage as SCU;
- Support Storage Commitment Service as SCU;
- Support Media Storage Service as FSC.

This document is intended to describe Aixplorer's conformance to DICOM 3.0.

Table 1.1 on page v provides an overview of the network services supported by Aixplorer and Table 1.2 on page v provides an overview of the Media Storage Application Profiles supported by Aixplorer.

SOP Classes	User of Service (SCU)	Provider of Service (SCP)
Transfer		
Ultrasound Image Storage	Yes ¹	Yes ²
Ultrasound Multi-Frame Image Storage	Yes ¹	Yes ²
Ultrasound Image Storage (Retired)	Yes ¹	Yes ²
Ultrasound Multi-Frame Image Storage (Retired)	Yes ¹	Yes ²
Secondary Capture Image Storage	No	Yes ²

Multi-Frame Single Bit Secondary Capture Image Storage	No	Yes ²
Multi-Frame Grayscale Byte Secondary Capture Image Storage	No	Yes ²
Multi-Frame Grayscale Word Secondary Capture Image Storage	No	Yes ²
Multi-Frame True Color Secondary Capture Image Storage	No	Yes ²
Encapsulated PDF Storage	Yes ¹	No
CT Image Storage	No	Yes ²
Enhanced CT Image Storage	No	Yes ²
MR Image Storage	No	Yes ²
Enhanced MR Image Storage	No	Yes ²
Digital Mammography X-Ray Image Storage - For Presentation	No	Yes ²
Digital Mammography X-Ray Image Storage - For Processing	No	Yes ²
Nuclear Medecine Image Storage	No	Yes ²
RETIRED Nuclear Medecine Image Storage	No	Yes ²
Computed Radiography Image Storage	No	Yes ²
Digital XRay Image Storage - For Presentation	No	Yes ²
Digital XRay Image Storage - For Processing	No	Yes ²
XRay Angiographic Image Storage	No	Yes ²
Enhanced XA Image Storage	No	Yes ²
XRay Radiofluoroscopic Image Storage	No	Yes ²
Enhanced XRF Image Storage	No	Yes ²
VL Endoscopic Image Storage	No	Yes ²
VL Microscopic Image Storage	No	Yes ²
Positron Emission Tomography Image Storage	No	Yes ²
	No	Yes ²
Query/Retrieve		
Study Root Query/Retrieve Information Model - FIND	Yes ²	No
Study Root Query/Retrieve Information Model - MOVE	Yes ²	No
Workflow Management		
Modality Worklist (C-FIND)	Yes ¹	No
Storage Commitment Push Model	Yes ¹	No
Modality Performed Procedure Step	Yes ¹	No

Print Management		
Basic Grayscale Print Management	Yes ¹	No
Basic Color Print Management	Yes ¹	No

Table 1.1: Network Services

Media Storage Application Profile	Write Files (FSC or FSU)	Read Files (FSR)
Compact Disk - Recordable		
General Purpose CD-R Profiles (STD-GEN-CD)	Yes ³ / No	No
Ultrasound application profile - Single Frame Image Display (STD-US-ID-SF-CDR)	Yes ³ / No	No
Ultrasound application profile - Single & Multi-Frame Image Display (STD-US-ID-MF-CDR)	Yes ³ / No	No
120 mm DVD		
General Purpose DVD Interchange with JPEG (STD-GEN-DVD-JPEG)	Yes ³ / No	No
Ultrasound application profile - Single Frame Image Display (STD-US-ID-SF-DVD)	Yes ³ / No	No
Ultrasound application profile - Single & Multi-Frame (STD-US-ID-MF-DVD)	Yes ³ / No	No
DVD Interchange with MPEG2 MP@ML (STD-DVD-MPEG2-MPML)	Yes ³ / No	No
USB connected removable devices⁴		
General Purpose USB Media Interchange with JPEG (STD-GEN-USB-JPEG)	Yes ³ / No	No

³Purchasable option.

⁴The DICOMDIR file is not in the root directory of the medium.

Table 1.2: Media Services

¹Purchasable option. (Basic DICOM option)

²Purchasable option. (Q/R DICOM option)

Contents

1	Conformance Statement Overview	iii
	Contents	vii
	List of Tables	xv
	List of Figures	xix
2	Introduction	1
2.1	Revision History	1
2.2	Audience	1
2.3	Remarks	2
2.4	Definitions, Terms and Abbreviations	2
2.4.1	Definitions	2
2.4.2	Basics of DICOM communication	5
2.4.3	Abbreviations and terms	6
2.5	References	7
3	Networking	9
3.1	Implementation Model	9
3.1.1	Application Data flow	9
3.1.1.1	Storage	9
3.1.1.2	Worklist	11
3.1.1.3	Modality Performed Procedure Step	11
3.1.1.4	Verification	11
3.1.1.5	Print Images	11
3.1.1.6	Storage commitment	11
3.1.1.7	Query/Retrieve	12
3.1.1.8	Storage SCP	12

3.1.2	Functional Definitions of Aixplorer Application Entities	12
3.1.2.1	Verification Service as both SCU and SCP	12
3.1.2.2	Basic Modality Worklist Management Service as SCU	12
3.1.2.3	Modality Performed Procedure Step Management Service as SCU	13
3.1.2.4	Image Storage Service as SCU	13
3.1.2.5	Storage Commitment Service as SCU	13
3.1.2.6	Basic Print Service as SCU	13
3.1.2.7	Query/Retrieve Service as SCU	13
3.1.2.8	Storage SCP	14
3.1.3	Sequencing of Real-World Activities	14
3.1.3.1	Sequencing of Real-World Activities - Send After Acquisition	14
3.1.3.2	Sequencing of Real-World Activities - End of Exam	15
3.1.3.3	Sequencing of Real-World Activities - Query/Retrieve	15
3.2	Application Entity Specifications	18
3.2.1	Storage SCU Application Entity Specification	18
3.2.1.1	SOP Classes	18
3.2.1.2	Association Policies	18
3.2.1.2.1	General	18
3.2.1.2.2	Number of Associations	18
3.2.1.2.3	Asynchronous Nature	19
3.2.1.2.4	Implementation Identifying Information	19
3.2.1.3	Association Initiation Policy	19
3.2.1.3.1	Description and Sequencing of Activity Send Instances	19
3.2.1.3.2	Proposed Presentation Contexts	20
3.2.1.3.3	SOP Specific Conformance for Storage SOP Class	23
3.2.1.3.4	SOP Specific Conformance for Storage Commitment SOP Class	25
3.2.1.3.4.1	Storage Commitment Operations (N-ACTION)	25

3.2.1.3.4.2	Storage Commitment Notifications (N-EVENT-REPORT)	25
3.2.1.4	Association Acceptance Policy	26
3.2.1.4.1	Activity - Receive Storage Commitment Response	26
3.2.1.4.1.1	Description and Sequencing of Activities	26
3.2.1.4.1.2	Accepted Presentation Contexts	30
3.2.1.4.1.3	SOP Specific Conformance for Storage Commitment SOP Class	30
3.2.1.4.1.3.1	Storage Commitment Notifications (N-EVENT-REPORT)	31
3.2.1.4.1.3.2	SOP Specific Conformance for Verification SOP Class	31
3.2.2	Workflow Application Entity Specification	31
3.2.2.1	SOP Classes	31
3.2.2.2	Association Policies	31
3.2.2.2.1	General	31
3.2.2.2.2	Number of Associations	32
3.2.2.2.3	Asynchronous Nature	32
3.2.2.2.4	Implementation Identifying Information	32
3.2.2.3	Association Initiation Policy	32
3.2.2.3.1	Activity - Refresh Worklist	32
3.2.2.3.1.1	Description and Sequencing of Activity	33
3.2.2.3.1.2	Proposed Presentation Contexts	33
3.2.2.3.1.3	Specific Conformance for Worklist Management SOP Class	33
3.2.2.3.2	Activity - Acquire images	38
3.2.2.3.2.1	Description and Sequencing of Activities	38

	3.2.2.3.2.2	Proposed Presentation Contexts	40
		
	3.2.2.3.2.3	Specific Conformance for MPPS SOP Class	40
		
	3.2.2.4	Association Acceptance Policy	46
3.2.3	Hardcopy Application Entity Specification	46
	3.2.3.1	SOP Classes	46
	3.2.3.2	Association Policies	46
	3.2.3.2.1	General	46
		
	3.2.3.2.2	Number of Associations	48
		
	3.2.3.2.3	Asynchronous Nature	48
		
	3.2.3.2.4	Implementation Identifying Information	48
		
	3.2.3.3	Association Initiation Policy	48
	3.2.3.3.1	Activity - print images	48
	3.2.3.3.1.1	Description and Sequencing of Activity	48
		
	3.2.3.3.1.2	Proposed Presentation Contexts	49
		
	3.2.3.3.1.3	SOP Specific Conformance for Print SOP Class	50
		
	3.2.3.3.1.3.1	Basic Printer SOP Class	50
		
	3.2.3.3.1.3.2	Basic Film Session SOP Class	51
		
	3.2.3.3.1.3.3	Basic Film Box SOP Class	51
		
	3.2.3.3.1.3.4	Basic Grayscale Image Box SOP Class	53
		
	3.2.3.3.1.3.5	Basic Color Image Box SOP Class	53
		
3.2.4	Verification Application Entity Specification	54
	3.2.4.1	SOP Classes	54
	3.2.4.2	Association Policies	54
	3.2.4.2.1	General	54
		

3.2.4.2.2	Number of Associations	55
3.2.4.2.3	Asynchronous Nature	55
3.2.4.2.4	Implementation Identifying Information	55
3.2.4.3	Association Initiation Policy	55
3.2.4.3.1	Activity - Verification SCU	55
3.2.4.3.1.1	Description and Sequencing of Activities	55
3.2.4.3.1.2	Proposed Presentation Contexts	56
3.2.5	Storage SCP Application Entity Specification	56
3.2.5.1	SOP Classes	56
3.2.5.2	Association Policies	56
3.2.5.2.1	General	56
3.2.5.2.2	Number of Associations	56
3.2.5.2.3	Asynchronous Nature	59
3.2.5.2.4	Implementation Identifying Information	59
3.2.5.3	Association Initiation Policy	59
3.2.5.4	Association Acceptance Policy	59
3.2.5.4.1	Activity – Store instances on local storage	59
3.2.5.4.1.1	Description and Sequencing of Activities	59
3.2.5.4.1.2	Accepted Presentation Contexts	61
3.2.5.4.1.2.1	Extended Negotiation	68
3.2.5.4.1.3	SOP Specific Conformance	68
3.2.5.4.1.3.1	SOP Specific Conformance to Storage SCP SOP Classes	68
3.2.5.4.1.3.2	SOP Specific Conformance to Storage SCP SOP Classes	68

	3.2.5.4.1.3.3	Transfer Syntax Selection Policies	68
		
	3.2.5.4.1.3.4	Response Status	69
		
3.2.6		Query/Retrieve Application Entity Specification	69
	3.2.6.1	SOP Classes	69
	3.2.6.2	Association Policies	69
	3.2.6.2.1	General	69
		
	3.2.6.2.2	Number of Associations	70
		
	3.2.6.2.3	Asynchronous Nature	70
	3.2.6.2.4	Implementation Identifying Information	70
	3.2.6.3	Association Initiation Policy	70
	3.2.6.3.1	Activity - Query Request	70
	3.2.6.3.1.1	Description and Sequencing of Activity	70
		
	3.2.6.3.1.2	Proposed presentation Context	71
		
	3.2.6.3.1.2.1	Extended Negotiation	71
		
	3.2.6.3.1.3	SOP Specific Conformance	71
	3.2.6.3.1.3.1	SOP Specific Conformance to C-FIND SOP Classes	71
		
	3.2.6.3.1.3.2	Presentation Context Acceptance Criterion	72
		
	3.2.6.3.1.3.3	Transfer Syntax Selection Policies	72
		
	3.2.6.3.1.3.4	Response Status	72
		
	3.2.6.3.2	Activity - Retrieve Exam	72
	3.2.6.3.2.1	Description and Sequencing of Activity	72
		
	3.2.6.3.2.2	Proposed presentation Context	72
		
	3.2.6.3.2.2.1	Extended Negotiation	75
		
	3.2.6.3.2.3	SOP Specific Conformance	75

	3.2.6.3.2.3.1	SOP Specific Conformance to C-FIND SOP Classes	75
		
	3.2.6.3.2.3.2	Presentation Context Acceptance Criterion	75
		
	3.2.6.3.2.3.3	Transfer Syntax Selection Policies	75
		
	3.2.6.3.2.3.4	Response Status	76
		
	3.2.6.3.2.3.5	Sub-operation dependent behavior	76
		
	3.2.6.4	Association Acceptance Policy	76
		
3.3		Network Interfaces	76
	3.3.1	Physical Network Interface	76
	3.3.2	Additional Protocols	78
		3.3.2.1 DHCP	78
		3.3.2.2 DNS	78
		3.3.2.3 NTP	79
		3.3.2.4 LDAP	79
	3.3.3	IPv4 and IPv6 Support	79
3.4		Configuration	79
	3.4.1	AE Title/Presentation Address Mapping	79
	3.4.2	Parameters	79
		
4		Media Interchange	81
	4.1	Implementation Model	81
		4.1.1 Application Data flow	81
		4.1.2 Functional Definitions of Application Entities	81
		4.1.2.1 Functional Definition of Media Creation Application Entity	81
		4.1.3 Sequencing of Real-World Activities	81
		4.1.4 File Meta Information for Implementation Class and Version	83
	4.2	Application Entity Specifications	83
		4.2.1 Offline-Media Application Entity Specification	83
		4.2.1.1 File Meta Information for the Application Entity	83
		4.2.1.2 Real-World Activities	83
		4.2.1.2.1 Activity – Export to CD-R DVD	83
		
		4.2.1.2.1.1 Media Storage Application Profiles	83
		

4.2.1.2.1.1	Options	85
4.2.1.2.2	Activity – Export to USB	86
4.2.1.2.2.1	Media Storage Application Profiles	86
4.2.1.2.2.2	Media Storage Application Profiles	86
4.3	Augmented and Private Application Profiles	88
4.4	Media Configuration	88
5	Support of Extended Character Sets	89
6	Security	91
	Appendix	95
A	IOD contents	95
A.1	Created SOP instances	95
A.1.1	US Image IOD Modules	95
A.1.2	US Multi-Frame Image IOD Module	96
A.1.3	Encapsulated PDF IOD Module	96
A.1.4	Common Modules	98
A.1.5	Extra Modules	107
A.2	Used Fields in received IOD	109
A.3	Attribute Mapping	109
A.3.1	Worklist-Instances-MPPS IOD mapping	109
A.3.2	Worklist attribute mapping in Aixplorer’s user interface	110
A.4	Coerced/Modified Fields	112
B	Data Dictionary of Private Attributes	115
C	Private Transfer Syntaxes	117

List of Tables

1.1	Network Services	v
1.2	Media Services	v
2.1	Revision history	1
3.1	SOP Classes for Storage AE	18
3.2	DICOM Application Context for Storage AE	18
3.3	Number of Associations as an Association Initiator for Storage AE	19
3.4	Number of Associations as an Association Acceptor for Storage AE	19
3.5	Asynchronous Nature as an Association Initiator for Storage AE	19
3.6	DICOM Implementation Class and Version for Storage AE	20
3.7	Proposed Presentation Contexts for Activity Send instances	21
3.8	Proposed Presentation Contexts for AE and Storage Commitment SCU Activity	23
3.9	Storage C-STORE response Status Handling Behavior	24
3.10	Storage Communication Failure Behavior	25
3.11	Storage Commitment N-ACTION Response Status Handling Behavior	25
3.12	Storage Commitment Communication Failure Behavior	26
3.13	Storage Commitment N-EVENT-REPORT behavior	27
3.14	Storage Commitment N-EVENT-REPORT Response Status Reasons	28
3.15	Association Rejection Reasons	30
3.16	Acceptable Presentation Contexts for Activity Receive Storage Commitment Response	30
3.17	SOP Classes for AE Workflow	31
3.18	DICOM Application Context for Workflow AE	31
3.19	Number of Associations as an Association Initiator for Workflow AE	32
3.20	Asynchronous Nature as an Association Initiator for Workflow AE	32
3.21	DICOM Implementation Class and Version for Workflow AE	32
3.22	Proposed Presentation Contexts for Workflow AE and Worklist SCU Activity	34
3.25	Worklist Request Identifier	37

3.23	Modality Worklist C-FIND response status handling behavior	39
3.24	Modality Worklist Communication Failure Behavior	40
3.27	Proposed Presentation Contexts for Workflow AE and MPPS SCU Activity	40
3.28	MPPS N-CREATE / N-SET Response Status Handling Behavior	42
3.29	MPPS Communication Failure Behavior	42
3.30	MPPS N-Create / N-Set Request Identifier	46
3.31	SOP Classes for AE Hardcopy	47
3.32	DICOM Application Context for Hardcopy AE	47
3.33	Number of Associations as an Association Initiator for Hardcopy AE	48
3.34	Asynchronous Nature as an Association Initiator for Hardcopy AE	48
3.35	DICOM Implementation Class and Version for Hardcopy AE	48
3.36	Proposed Presentation Contexts for Hardcopy AE and Print SCU Activity	50
3.37	Number of Copies for Basic Film Session	51
3.38	Basic Film Session SOP Class N-CREATE request attributes	51
3.39	Basic Film Box SOP Class N-CREATE attributes	52
3.40	Basic Film Box SOP Class N-SET attributes	52
3.41	Basic Grayscale Image Box SOP Class Request attributes	53
3.42	Basic Color Image Box SOP Class Request attributes	54
3.43	SOP Classes for AE Verification	54
3.44	DICOM Application Context for Verification AE	55
3.45	Number of Associations as an Association Initiator for Verification AE	55
3.46	Asynchronous Nature as an Association Initiator for Verification AE	55
3.47	DICOM Implementation Class and Version for Verification AE	56
3.48	Presentation Context Table for Verification SCU	56
3.49	SOP Classes for Storage SCP AE	58
3.50	Maximum PDU size received as a SCP for Storage SCP	58
3.51	Number of Associations as a SCP for Storage SCP AE	58
3.52	DICOM Implementation Class and Version for Storage SCP AE	59
3.53	Acceptable Presentation Contexts for Storage SCP and receive storage request	67
3.54	Acceptable Presentation Contexts for Storage SCP and receive Echo request	68
3.55	Response Status for Storage SCP and Receive Storage Request	69
3.56	SOP Classes for AE Query/Retrieve	69
3.57	DICOM Application Context for Query/Retrieve AE	70
3.58	Number of Associations as an Association Initiator for Query/Retrieve AE	70
3.59	Asynchronous Nature as an Association Initiator for Query/Retrieve AE	70
3.60	DICOM Implementation Class and Version for Query/Retrieve AE	71
3.61	Proposed Presentation Contexts for Activity Query Request	71
3.62	Study Root request identifier for Find SCU	73
3.63	Response Status for Find SCU and Query Remote AE Request	74
3.64	Proposed Presentation Contexts for Activity Retrieve Exam Request	75
3.65	Response Status for Move SCU and retrieve from Remote AE Request	77

3.66	Supported System Management profiles	78
3.67	Supported DHCP Parameters	78
4.1	DICOM Implementation Class and Version for DICOMDIR creation	83
4.2	Application Profiles, activities, and roles for Offline Media	84
4.3	Media Storage Application Profiles for CDR/DVD	84
4.4	IODs, SOP Classes and Transfer Syntaxes for the Offline media	86
4.5	IODs, SOP Classes and Transfer Syntaxes for the Offline media	87
5.1	Supported Character Set	90
A.1	US Image IOD Modules	96
A.2	US Multi-Frame Image IOD Module	97
A.3	Encapsulated PDF IOD Module	97
A.4	Patient Module Attributes of created SOP Instances	98
A.5	General Study Module of created SOP Instances	99
A.6	Patient Study Module of created SOP Instances	99
A.7	General Series Module of created SOP Instances	100
A.8	Encapsulated Document Series Module of created SOP Instances	101
A.9	General Equipment Module of created SOP Instances	101
A.10	Enhanced General Equipment Module of created SOP Instances	101
A.11	Device Module of created SOP Instances	102
A.12	General Image Module of created SOP Instances	102
A.13	Image Pixel Module of created SOP Instances	103
A.14	Contrast/Bolus Module of created SOP Instances	103
A.15	Cine Module of created US Multi-frame SOP Instances	103
A.16	Multi-Frame Module of created US Multi-frame SOP Instances	103
A.17	US Region Calibration Module of created SOP Instances	104
A.18	US Image Module of created SOP Instances	104
A.19	VOI LUT Module of created SOP Instances	105
A.20	SC Equipment Module of created SOP Instances	105
A.21	SOP Common Module of created SOP Instances	105
A.22	Encapsulated Document Module of created SOP Instances	106
A.23	Extra Module of created SOP Instances	107
A.24	Extra Module of created SOP Instances for Encapsulated PDF IOD	108
A.25	Attribute Mapping between Modality Worklist, Images and MPPS	110
A.26	Attribute Mapping between Modality Worklist, Worklist and Patient Data windows	112
A.27	De-Identified attributes	113
B.1	Data Dictionary of Private Attributes	116

List of Figures

3.1.1 Application Data Flow	10
3.1.2 Sequencing Constraints - Send After Acquisition configuration	16
3.1.3 Sequencing Constraints - End of Exam configuration	17
3.2.1 Sequencing of Activity - Send Images	22
3.2.2 Sequencing of Activity - Receive Storage Commitment Response	29
3.2.3 Sequencing of Activity - Worklist SCU	34
3.2.4 Sequencing of Activity - MPPS SCU	41
3.2.5 Sequencing of Activity - Print SCU	49
3.2.6 Sequencing of Activity - CEcho SCU	57
3.2.7 Sequencing of Activity - Send Images	60
4.1.1 Application Data Flow for Media Storage	82

Chapter 2

Introduction

2.1 Revision History

The revision history of this document is available on Table 2.1.

Document Version	Date	Author	Description
Version 01	June 13, 2012	Damien LERAT	Creation
Version 02	July 5, 2012	Damien LERAT	Contraste Private Tags added

Table 2.1: *Revision history*

For any other information, or for the latest version of this document, please contact:

SuperSonic Imagine

DICOM and Connectivity Management

Les Jardins de la Duranne - Bat. E & F

510, rue René Descartes

FRANCE - 13857 Aix-en-Provence Cedex

E-mail: dicom@supersonicimagine.fr

Web site: <http://www.supersonicimagine.fr/dicom>

2.2 Audience

This document is written for the people that need to understand how Aixplorer will integrate into their healthcare facility. This includes both those responsible for overall imaging network

policy and architecture, as well as integrators who need to have a detailed understanding of the DICOM features of the product. This document contains some basic DICOM definitions so that any reader may understand how this product implements DICOM features. However, integrators are expected to fully understand all the DICOM terminology, how the tables in this document relate to the product's functionality, and how that functionality integrates with other devices that support compatible DICOM features.

2.3 Remarks

The scope of this DICOM Conformance Statement is to facilitate integration between Aixplorer and other DICOM products. The Conformance Statement should be read and understood in conjunction with the DICOM Standard. DICOM by itself does not guarantee interoperability. The Conformance Statement does, however, facilitate a first-level comparison for interoperability between different applications supporting compatible DICOM functionality.

This Conformance Statement is not supposed to replace validation with other DICOM equipment to ensure proper exchange of intended information. In fact, the user should be aware of the following important issues:

- The comparison of different Conformance Statements is just the first step towards assessing interconnectivity and interoperability between Aixplorer and other DICOM conformant equipment.
- Test procedures should be defined and executed to validate the required level of interoperability with specific compatible DICOM equipment, as established by the healthcare facility.
- The DICOM standard will evolve to meet the users' future requirements. SuperSonic Imagine is actively involved in developing the standard further and therefore reserves the right to make changes to its products or to discontinue its delivery.

2.4 Definitions, Terms and Abbreviations

Definitions, terms and abbreviations used in this document are defined within the different parts of the DICOM standard.

2.4.1 Definitions

Informal definitions are provided for the following terms used in this Conformance Statement. The DICOM Standard is the authoritative source for formal definitions of these terms.

Abstract Syntax: the information agreed to be exchanged between applications, generally

equivalent to a Service/Object Pair (SOP) Class. Examples : Verification SOP Class, Modality Worklist Information Model Find SOP Class, Computed Radiography Image Storage SOP Class.

Application Entity (AE): an end point of a DICOM information exchange, including the DICOM network or media interface software; *i.e.*, the software that sends or receives DICOM information objects or messages. A single device may have multiple *Application Entities*.

Application Entity Title: the externally known name of an *Application Entity*, used to identify a DICOM application to other DICOM applications on the network.

Application Context: The specification of the type of communication used between *Application Entities*. Example: DICOM network protocol.

Association: A network communication channel set up between *Application Entities*.

Attribute: a unit of information in an object definition; a data element identified by a *tag*. The information may be a complex data structure (Sequence), itself composed of lower level data elements. Examples: Patient ID (0010,0020), Accession Number (0008,0050), Photometric Interpretation (0028,0004), Procedure Code Sequence (0008,1032).

Command: A request to operate on information across a network.

Command Element: An encoding of a parameter of a command which conveys this parameter's value.

Command Stream: The result of encoding a set of DICOM *Command Elements* using the DICOM encoding scheme.

Conformance Statement: A formal statement that describes a specific product implementation that uses the DICOM Standard. It specifies the *Service Classes*, *Information Objects*, and Communication Protocols supported by the implementation.

Data Dictionary: A registry of DICOM *Data Elements* which assigns a unique *tag*, a name, value characteristics, and semantics to each *Data Element*.

Data Element: A unit of information as defined by a single entry in the *Data Dictionary*.

Data Set: Exchanged information consisting of a structured set of *Attributes*. The value of each *Attribute* in a *Data Set* is expressed as a *Data Element*.

Data Stream: The result of encoding a *Data Set* using the DICOM encoding scheme (Data Element Numbers and representations as specified by the Data Dictionary).

Information Object: An abstraction of a real information entity (*e.g.*, CT Image, Structured Report, *etc.*) which is acted upon by one or more DICOM Commands.

Information Object Class: A formal description of an *Information Object* which includes a description of its purpose and the *Attributes* it possesses. It does not include values for these *Attributes*.

Information Object Definition (IOD): the specified set of *Attributes* that comprise a type of data object; does not represent a specific instance of the data object, but rather a class of similar data objects that have the same properties. The *Attributes* may be specified as Mandatory (Type 1), Required but possibly unknown (Type 2), or Optional (Type 3), and there may be conditions associated with the use of an Attribute (Types 1C and 2C). Examples: MR Image IOD, CT Image IOD, Print Job IOD.

Information Object Instance: A representation of an occurrence of a real-world entity, which includes values for the *Attributes* of the *Information Object Class* to which the entity belongs.

Joint Photographic Experts Group (JPEG): A set of standardized image compression techniques, available for use by DICOM applications.

Media Application Profile: The specification of DICOM *Information Objects* and encoding exchanged on removable media (e.g. CDs).

Message: A data unit of the Message Exchange Protocol exchanged between two cooperating DICOM Applications. A *Message* is composed of a *Command Stream* followed by an optional *Data Stream*.

Module: A set of *Attributes* within an *Information Object Definition* that are logically related to each other. Example: Patient Module includes Patient Name, Patient ID, Patient Birth Date, and Patient Sex.

Negotiation: First phase of *Association* establishment that allows *Application Entities* to agree on the types of data to be exchanged and how that data will be encoded.

Presentation Context: The set of DICOM network services used over an *Association*, as negotiated between *Application Entities*; includes *Abstract Syntaxes* and *Transfer Syntaxes*.

Protocol Data Unit (PDU): A packet (piece) of a DICOM message sent across the network. Devices must specify the maximum size packet they can receive for DICOM messages.

Security Profile: A set of mechanisms, such as encryption, user authentication, or digital signatures, used by an *Application Entity* to ensure confidentiality, integrity, and/or availability of exchanged DICOM data.

Service Class: A structured description of a service which is supported by cooperating DICOM Applications using specific DICOM Commands acting on a specific class of *Information Object*.

Service Class Provider (SCP): Role of an *Application Entity* that provides a DICOM network service; typically, a server that performs operations requested by another *Application Entity* (*Service Class User*). Examples: Picture Archiving and Communication System (image storage SCP, and image query/retrieve SCP), Radiology Information System (modality Worklist SCP).

Service Class User (SCU): Role of an *Application Entity* that uses a DICOM network service; typically, a client. Examples: imaging modality (image storage SCU, and modality Worklist SCU), imaging workstation (image query/retrieve SCU).

Service/Object Pair (SOP) Class: The specification of the network or media transfer (service) of a particular type of data (object); the fundamental unit of DICOM interoperability specification. Examples: Ultrasound Image Storage Service, Basic Grayscale Print Management.

Service/Object Pair (SOP) Instance: An *Information Object*; a specific occurrence of information exchanged in a *SOP Class*. Examples: a specific x-ray image.

Tag: a 32-bit identifier for a data element, represented as a pair of four digit hexadecimal numbers, the “group” and the “element”. If the “group” number is odd, the tag is for a private (manufacturer-specific) *Data Element*. Examples: (0010,0020) [Patient ID], (07FE,0010) [Pixel Data], (0019,0210) [Private Data Element].

Transfer Syntax: The encoding used for exchange of DICOM *Information Objects* and *Messages*. Examples: JPEG compressed (images), little Endian explicit value representation.

Unique Identifier (UID): A globally unique “dotted decimal” string that identifies a specific object; an ISO-8824 Object Identifier. Examples: Study Instance UID, SOP Class UID, SOP Instance UID.

Value Representation (VR): The format type of an individual DICOM data element, such as text, an integer, a person’s name, or a code. DICOM information objects can be transmitted with either explicit identification of the type of each data element (Explicit VR), or without explicit identification (Implicit VR); with Implicit VR, the receiving application must use a DICOM data dictionary to look up the format of each data element.

2.4.2 Basics of DICOM communication

This section describes terminology used in this Conformance Statement for the non-specialist. The key terms used in the *Conformance Statement* are highlighted in *italics* below. This section is not a substitute for training about DICOM, and it makes many simplifications about the meanings of DICOM terms.

Two *Application Entities* (devices) that want to communicate with each other over a network using DICOM protocol must first agree on several things during an initial network “handshake”. One of the two devices must initiate an *Association* (a connection to the other device), and ask if specific services, information, and encoding can be supported by the other device (*Negotiation*). DICOM specifies a number of network services and types of *Information Objects*, each of which is called an *Abstract Syntax* for the *Negotiation*. DICOM also specifies a variety of methods for encoding data, denoted *Transfer Syntaxes*. The *Negotiation* allows the initiating *Application Entity* to propose combinations of *Abstract Syntax* and *Transfer Syntax* to be used on the *Association*; these combinations are called *Presentation Contexts*. The receiving *Application Entity* accepts the *Presentation Contexts* it supports.

For each *Presentation Context*, the *Association Negotiation* also allows the devices to agree on *Roles* – which one is the *Service Class User* (SCU - client) and which is the *Service Class Provider* (SCP - server). Normally the device initiating the connection is the SCU, *i.e.*, the client system calls the server, but not always.

The *Association Negotiation* finally enables exchange of maximum network packet (PDU) size, security information, and network service options (called *Extended Negotiation* information). The *Application Entities*, having negotiated the *Association* parameters, may now commence exchanging data. Common data exchanges include queries for Worklists and lists of stored images, transfer of image objects and analyses (structured reports), and sending images to film printers. Each exchangeable unit of data is formatted by the sender in accordance with the appropriate *Information Object Definition*, and sent using the negotiated *Transfer Syntax*. There is a *Default Transfer Syntax* that all systems must accept, but it may not be the most efficient for some use cases. Each transfer is explicitly acknowledged by the receiver with a *Response*

Status indicating success, failure, or that query or retrieve operations are still in process. Two *Application Entities* may also communicate with each other by exchanging media (such as a CD-R). Since there is no *Association Negotiation* possible, they both use a *Media Application Profile* that specifies “pre-negotiated” exchange media format, *Abstract Syntax*, and *Transfer Syntax*.

2.4.3 Abbreviations and terms

ACR:	American College of Radiology
AE:	Application Entity
AET:	Application Entity Title
CD-R:	Compact Disk Recordable
DHCP:	Dynamic Host Configuration Protocol
DICOM:	Digital Imaging and Communications in Medicine
DNS:	Domain Name System
FSC:	File-Set Creator
FSU:	File-Set Updater
FSR:	File-Set Reader
HIS:	Hospital Information System
HL7:	Health Level 7 Standard
IHE:	Integrating the Healthcare Enterprise
IOD:	Information Object Definition
IPv4:	Internet Protocol version 4
IPv6:	Internet Protocol version 6
ISO:	International Organization for Standards
JPEG:	Joint Photographic Experts Group
MPEG:	Moving Picture Experts Group
MPPS:	Modality Performed Procedure Step
MTU:	Maximum Transmission Unit (IP)
MWL:	Modality Worklist
NEMA:	National Electrical Manufacturers Association
O	Optional (Key Attribute)
OSI:	Open Systems Interconnection
PACS:	Picture Archiving and Communication System
PDE:	Patient Data Entry
PDU:	Protocol Data Unit
R	Required (Key Attribute)
RIS:	Radiology Information System
SPS:	Scheduled Procedure Step

SC:	Secondary Capture
SR:	Structured Reporting
SCP:	Service Class Provider
SCU:	Service Class User
SOP:	Service-Object Pair
SPS:	Scheduled Procedure Step
SR:	Structured Reporting
TCP/IP:	Protocol Transmission Control Protocol/Internet
U Unique (Key Attribute)	
UID:	Unique Identifier
UL :	Upper Layer
US:	Ultrasound
US MF:	Ultrasound Multi-Frame
VR:	Value Representation

2.5 References

NEMA PS3 Digital Imaging and Communications in Medicine (DICOM) Standard, available free at <http://medical.nema.org/>

User's Guide SSIP01154-04C - Aixplorer V4 User's Guide US or SSIP01123-04C - Aixplorer V4 User's Guide EN

Chapter 3

Networking

3.1 Implementation Model

Aixplorer is implemented in six Application entities. Figure 3.1.1 on the next page illustrates the Aixplorer *Application Entities* (AE), (in the boxes) and relationships between user invoked activities (in the circles at the left of the AE) and the DICOM services (depicted in the circles at the right of the AE). Exam data are sent to all selected Store and Print destinations simultaneously in accordance with system configuration of “Send After Acquisition” or at “End of Exam” or Manual. Worklist queries are executed either manually or automatically. Modality Performed Procedure Step (MPPS) messages are sent at exam opening and closing. Query/Retrieve requests are executed either manually or automatically and selected instance are pushed to the local storage and added to the local database.

3.1.1 Application Data flow

3.1.1.1 Storage

Aixplorer sends single and multi-frame ultrasound images and PDF reports to one or several remote AEs. Acquisition of images is associated with the local real-world activities “Save Clip” for multi-frame images and “Save Image” for single frame images. Sending or exporting of images depends on user configuration, either “Send After Acquisition” or “End of Exam” (when “End of Exam” button is pressed), or Manual. PDF reports creation are associated with the real world activities “Report”. Sending or exporting of reports also depends on user configuration, either “End of Exam” (when “End of Exam” button is pressed), or Manual.

For either “Send After Acquisition” or “End of Exam”, or manual mode, each remote AE can be individually configured to accept or reject single frame images, multi-frames images, or PDF report.

Please refer to the user’s guide for configuration and use of DICOM Storage.

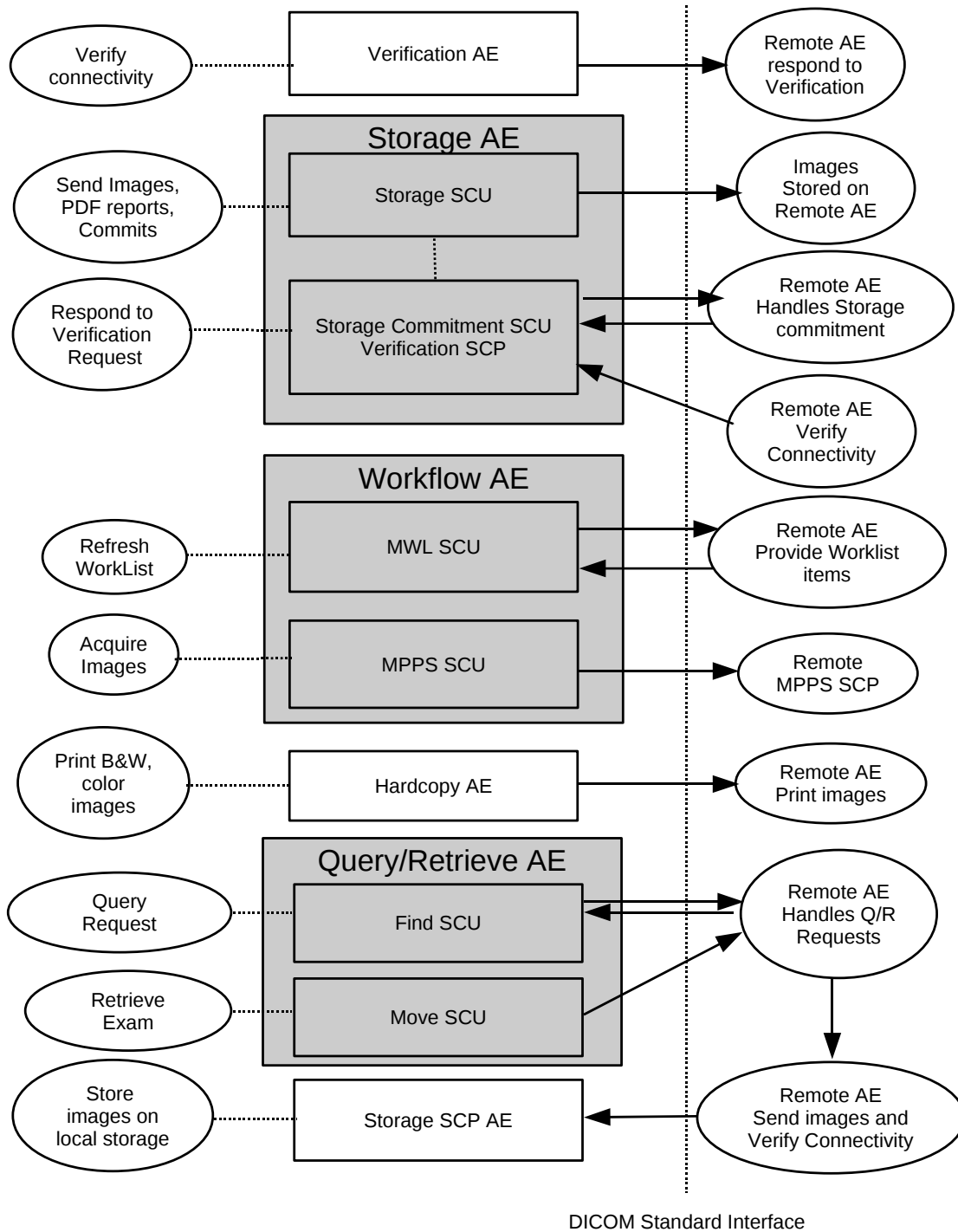

Figure 3.1.1: Application Data Flow

3.1.1.2 Worklist

Aixplorer queries Worklist information from remote AE. It is associated with the local real-world activities “Refresh” or automatic refresh (at a user configured refresh rate). When either the “Refresh” or automatic refresh are performed, Aixplorer queries a remote AE for Worklist items that provides the set of Worklist items matching the query request.

Please refer to the user’s guide for configuration and use of DICOM Worklist.

3.1.1.3 Modality Performed Procedure Step

Aixplorer sends Modality Performed Procedure Step message to remote AE. Messages are send automatically at exam opening and closing. Exam is said to be opened when patient information have been filled either automatically by selecting a patient in the Worklist or manually and a first image have been acquired. In this case, the message is send with the “In-Progress” Status. Exam is closed with the status “completed” by either pressing the “End of Exam” button located on the control panel or by pressing “new patient” on the touch screen. A third way to close an exam is to press the “Cancel Exam” button on the touch screen. A “discontinued” message status is then sent.

Please refer to the user’s guide for configuration and use of DICOM Modality Performed Procedure Step.

3.1.1.4 Verification

Aixplorer initiates a connection with a remote AE, posts a Verification request and closes the connection. It also responds to incoming Verification requests (for service use).

3.1.1.5 Print Images

Aixplorer sends single images to one or several remote AEs (Printer or Print Server). Acquisition of images is associated with the local real-world activities “Save Image”. Printing of images depends on user configuration, either “Send After Acquisition” or “End of Exam” (when “End of Exam” button is pressed), or Manual.

For either “Send After Acquisition” or “End of Exam”, or manual mode, each remote AE can be individually configured to send fully rendered pages already containing the user’s selected formatting choices.

Please refer to the user’s guide for configuration and use of DICOM Printing.

3.1.1.6 Storage commitment

Aixplorer sends single and multi-frame images and PDF reports to one or several remote AEs. Acquisition of images is associated with the local real-world activities “Save Clip” for multi-frame images and “Save Image” for single frame images. Sending or exporting of images depends on user configuration, either “Send After Acquisition” or “End of Exam” (when “End

of Exam” button is pressed), or Manual. PDF reports creation are associated with the real world activities “Report”. Sending or exporting of reports also depends on user configuration, either “End of Exam” (when “End of Exam” button is pressed), or Manual.

For either “Send After Acquisition”, “End of Exam”, or manual mode, each remote AE can be individually configured to accept or reject single frame images, multi-frame images, and PDF report.

The Storage AE will request Storage Commitment and if a commitment is successfully obtained will record this information in the local database.

Please refer to the user’s guide for configuration and use of DICOM Storage Commitment.

3.1.1.7 Query/Retrieve

Aixplorer queries remote AE’s for lists of studies and series matching user’s request. If a selection of series is requested for retrieval, then an association is established to a remote query/retrieve AE and a move order is sent in destination to Aixplorer’s local storage SCP.

Please refer to the user’s guide for configuration and use of DICOM Query/Retrieve.

3.1.1.8 Storage SCP

Storage SCP receives incoming images. This images may be unsolicited instances send by any remote Application Entities or may be instances requested thanks to the Query/Retrieve interface.

Please refer to the user’s guide for configuration and use of DICOM Query/Retrieve.

3.1.2 Functional Definitions of Aixplorer Application Entities

As an acquisition modality, Aixplorer mainly act as a SCU and connects to other DICOM applications. However, if Query/Retrieve option is enabled, then Aixplorer accept incoming storage request as a store SCP. Moreover, conceptually the network services may be modeled as separate AEs, but in fact MWL SCU, MPPS SCU, image storage SCU, storage commitment SCU and print SCU share a single (configurable) AE Title.

3.1.2.1 Verification Service as both SCU and SCP

Aixplorer can initiate associations with Presentation Contexts for the Verification service SOP class. It will send a C-ECHO request to another DICOM application and wait for a response to complete the verification. Moreover Aixplorer will answer to any C-ECHO request coming from other DICOM application.

3.1.2.2 Basic Modality Worklist Management Service as SCU

Aixplorer uses the Basic Worklist Management service to get required information to build its DICOM datasets.

It establishes one association with the remote Worklist SCP, performs a Find request, waits for responses, and then releases the association. During receiving, the Worklist response items are counted and the query processing is canceled if the configurable limit of items is reached. The results will be displayed in a separate list, which will be cleared with the next Worklist update.

3.1.2.3 Modality Performed Procedure Step Management Service as SCU

Aixplorer establishes one association with the remote MPPS SCP, send a N-Set or N-Create message, waits for responses, and then releases the association.

3.1.2.4 Image Storage Service as SCU

The existence of a send-job queue entry with associated network destination will activate the Storage AE. An association request is sent to the destination AE and upon successful negotiation of a Presentation Context the image transfer is started. If the association cannot be opened, the related send-job is set to an error state with an error message. Aixplorer will try two other times to initiate another association with 20 seconds between each retry. If send-job is still failing then the job is automatically paused and a notification icon is displayed in the notification panel. The number of retry and the idle period between each retry are both configurable in the set up.

3.1.2.5 Storage Commitment Service as SCU

Aixplorer uses the Storage Commitment service to check that a commitment is taken by the server receiving the stored images. After a Storage operation, Aixplorer establish one association with the remote Storage Commitment SCP, performs a Store Commit request, and then releases the association. The answer is waited for another association started by the Storage Commitment SCP. An automatic deletion mechanism, triggered off upon reception of commitment message, can be activated.

3.1.2.6 Basic Print Service as SCU

The existence of a print-job in the print queue will activate the Hardcopy AE. An association is established with the printer. If the printer is operating normally, the film sheets described within the print-job will be printed. If the printer is not operating normally, Aixplorer will try to send again the print-job two other times to initiate another association with 20 seconds between each retry. If print-job is still failing then the job is automatically paused and a notification icon is displayed in the notification panel.

The number of retry and the idle period between each retry are both configurable in the set up.

3.1.2.7 Query/Retrieve Service as SCU

Aixplorer uses the Query/Retrieve service as a SCU to query a remote AE. Query/Retrieve service can be decomposed in two basic tasks:

- first FIND requests or queries are executed on a remote AE to perform a match of all the keys specified in the request against the information it possesses. All queries are performed recursively from the study through the series levels until all matching series have been listed. The query keys are patient's name, patient id, accession number, study date, modality.
- then, eventually, a MOVE order is sent to the remote AE to move a list of series on Aixplorer local storage SCP.

There are two different ways to start Query requests. If the automatic query settings is activated then queries are automatically performed at exam creation. Queries can also be performed manually when the “Q/R” hard button on the control panel is pushed. If the automatic retrieve settings is activated or when a list of series is manually selected, a move request is sent.

3.1.2.8 Storage SCP

If Query/retrieve option is enabled, Aixplorer use the Storage Service Class to accept association from any SCU. Storage Service waits in the background for unsolicited or requested instances sent by remote AE. It will accept any associations with Presentation Contexts for SOP Classes of the Storage Service Class or Verification service class, and will store the received instances to the local database where they may subsequently be listed and viewed through the Query/Retrieve user interface.

3.1.3 Sequencing of Real-World Activities

On Aixplorer, images can be pushed on a remote Print, Store, Store commit server in three ways : “after acquisition”, “on End of Exam”, and “manually”. It is possible to configure individually each server. Moreover, at any time, during an exam or not, it is possible to start a query or retrieve a list of series.

3.1.3.1 Sequencing of Real-World Activities - Send After Acquisition

Under normal scheduled workflow conditions the sequencing constraints illustrated in Figure 3.1.2 on page 16 apply:

1. Query Worklist
2. Receive Worklist
3. Start acquisition and create MPPS with “IN-PROGRESS” status
4. Acquire and Store image
5. Request a Storage Commitment (if any Store Commit is configured)

6. Print acquired images on film (if film sheet is full)
7. Send MPPS with “DISCONTINUED” status (if “Cancel Exam” is pressed)
8. or Send MPPS with “COMPLETED” status (if “End of Exam” is pressed)
9. Print remaining images on film
10. Store pdf report
11. Wait and accept commitment response(s)

Other workflow situations (*e.g.* unscheduled procedure) will have other sequencing constraints. Printing could be omitted completely if no printer is connected or hardcopies are not required.

3.1.3.2 Sequencing of Real-World Activities - End of Exam

Under normal scheduled workflow conditions the sequencing constraints illustrated in Figure 3.1.3 on page 17 apply:

1. Query Worklist
2. Receive Worklist
3. Start acquisition and create MPPS with “IN-PROGRESS” status
4. Send MPPS with “DISCONTINUED” status (if “Cancel Exam” is pressed)
5. or Send MPPS with “COMPLETED” status (if “End of Exam” is pressed)
6. Store acquired images and pdf report
7. Print acquired images on film
8. Request a Storage Commitment (if any Store Commit is configured)
9. Wait and accept commitment response(s)

Other workflow situations (*e.g.* unscheduled procedure) will have other sequencing constraints. Printing could be omitted completely if no printer is connected or hardcopies are not required.

3.1.3.3 Sequencing of Real-World Activities - Query/Retrieve

If “Automatic Query” setting is activated, then Aixplorer will send automatically queries to a remote server. The keys for the query are Patient’s Name and/or Patient ID and/or Accession Number. The queries are send after the first image acquisition. If “automatic retrieve” setting is activated, Aixplorer will retrieve automatically the latest study. Otherwise, manual queries can be started at anytime, with or without any active exam.

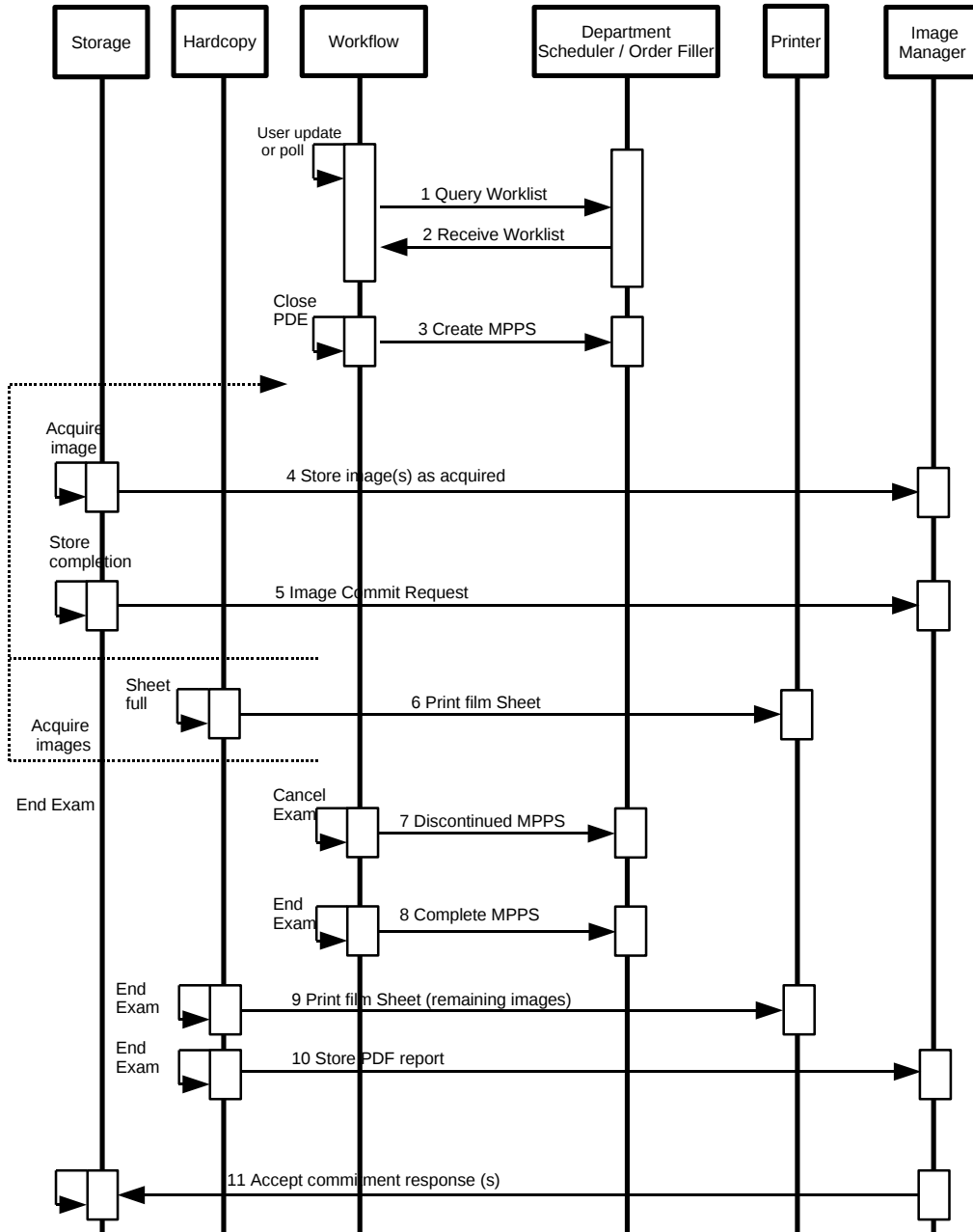

Figure 3.1.2: Sequencing Constraints - Send After Acquisition configuration

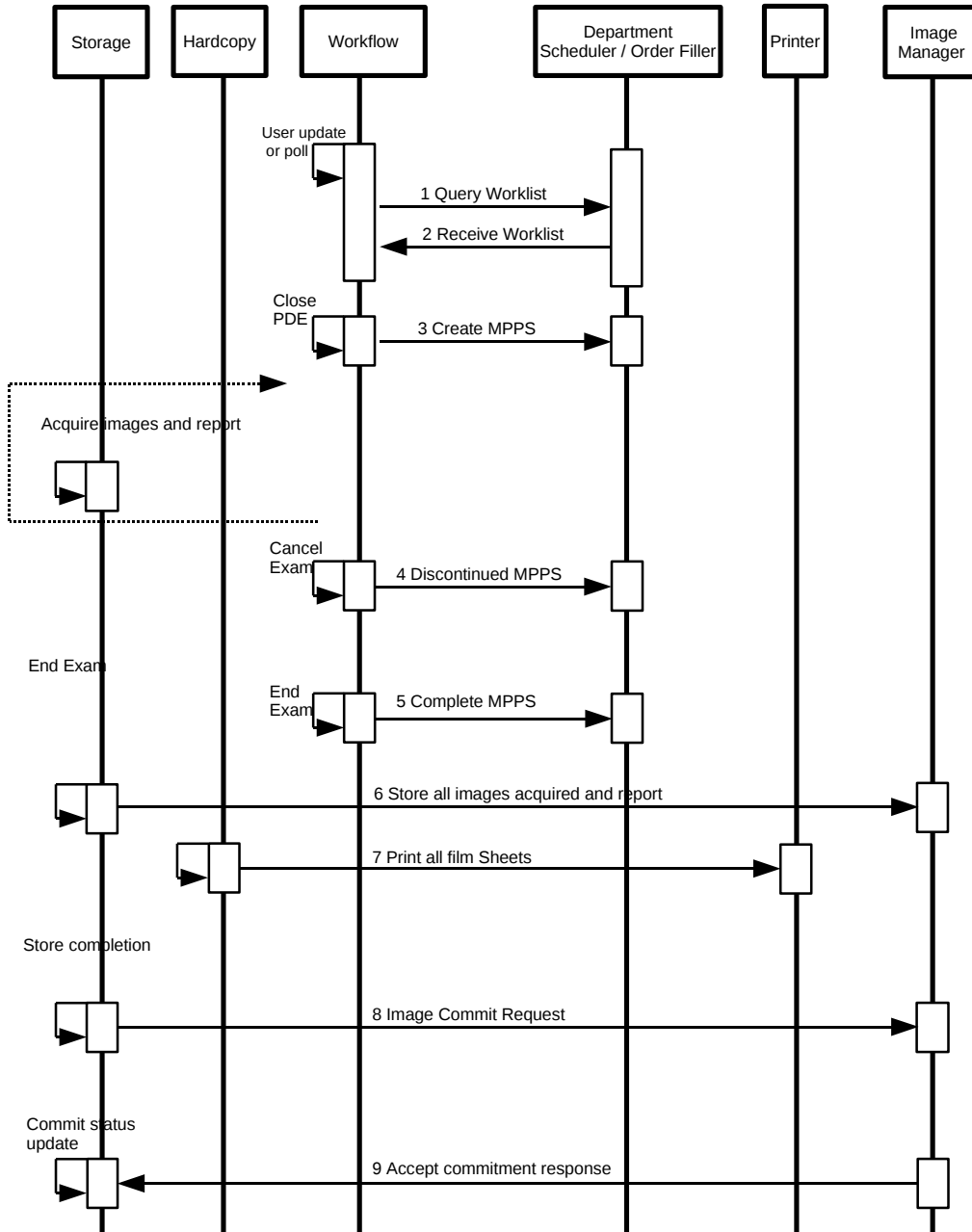

Figure 3.1.3: Sequencing Constraints - End of Exam configuration

3.2 Application Entity Specifications

3.2.1 Storage SCU Application Entity Specification

3.2.1.1 SOP Classes

The Aixplorer's Storage SCU AE provides Standard Conformance to the DICOM 3.0 SOP Classes described in Table 3.1.

SOP Class Name	SOP Class UID	SCU	SCP
US Image Storage	1.2.840.10008.5.1.4.1.1.6.1	Yes	No
US Multi-Frame Image Storage	1.2.840.10008.5.1.4.1.1.3.1	Yes	No
Encapsulated PDF Storage	1.2.840.10008.5.1.4.1.1.104.1	Yes	No
(Retired) US Image Storage	1.2.840.10008.5.1.4.1.1.6	Yes	No
(Retired) US Multi-Frame Image Storage	1.2.840.10008.5.1.4.1.1.3	Yes	No

Table 3.1: *SOP Classes for Storage AE*

3.2.1.2 Association Policies

3.2.1.2.1 General

As illustrated in Table 3.2, the DICOM 3.0 standard Application context is always specified for each association.

Application Context Name	1.2.840.10008.3.1.1.1
--------------------------	-----------------------

Table 3.2: *DICOM Application Context for Storage AE*

3.2.1.2.2 Number of Associations

The Storage AE may initiates one Association at a time (see Table 3.3 on the facing page) for each destination to which a transfer request is being processed in the active job queue list. Only one job will be active at a time, the other remains :

- pending until the active job is completed or failed,
- paused until they are resumed.

The Storage AE may accept an unlimited number of association (Table 3.4 on the next page) to receive N-EVENT-REPORT notifications for the Storage Commitment Push Model SOP Class and C-ECHO requests for the Verification service SOP Class.

Maximum number of simultaneous Associations	1
---	---

Table 3.3: *Number of Associations as an Association Initiator for Storage AE*

Maximum number of simultaneous Associations	unlimited
---	-----------

Table 3.4: *Number of Associations as an Association Acceptor for Storage AE*

3.2.1.2.3 Asynchronous Nature

As illustrated in Table 3.5, The Storage AE does not support asynchronous communication (multiple outstanding transactions over a single Association).

Maximum number of outstanding asynchronous transactions	0
---	---

Table 3.5: *Asynchronous Nature as an Association Initiator for Storage AE*

3.2.1.2.4 Implementation Identifying Information

The implementation information for the Storage Application Entity is described in Table 3.6 on the next page.

3.2.1.3 Association Initiation Policy

3.2.1.3.1 Description and Sequencing of Activity Send Instances

As described in section 3.1.1.1 on page 9, a user can manually select instances from Review Mode and request them to be sent to multiple destinations. Each request is forwarded to the “DICOM Store” job queue and processed individually if the “group exportation” option is active (default). Otherwise a job per instance will be created. When the “Send After Acquisition” or “Send on End of Exam” option are active, each acquired instances will be forwarded to the “DICOM Store” job queue for a pre-configured list of target destinations. It can be configured which type of instances (still images, clips, PDF reports) will be accepted by each destination. The Storage AE is invoked by the job list interface that is responsible for processing network archival tasks. The job consists of data describing the instances marked for storage and the destination. An internal daemon process triggered by a job for a specific Storage destination initiates a C-STORE request to store instances. If the process successfully establishes an Association to a remote Application Entity, it will transfer each instance one after another via the open Association. Status of the transfer is reported through the job list interface. Only one Storage job will be active at a time. If the C-STORE Response from the remote Application contains a status other than Success or Warning, the Association is aborted and the related Job

Implementation Class UID	1.2.250.1.59.3.0.3.5.3
Implementation Version Name	ETIAM_DCMTK_353

Table 3.6: DICOM Implementation Class and Version for Storage AE

is switched to a failed state. It will be restarted automatically later.

The Storage AE attempts to initiate a new Association in order to issue a C-STORE request. If the job contains multiple instances then multiple C-STORE requests will be issued over the same Association. If the Remote AE is configured as an archive device, after all instances have been successfully sent, a Storage Commitment request is issued. This Storage Commitment request will be sent over a separate association. Aixplorer will open a separate association for this, send a N-ACTION request to the server and wait for the N-ACTION response on this association. Aixplorer then releases this association, without expecting any N-EVENT-REPORT message. Aixplorer expects N-EVENT-REPORTS messages to be sent over a separate association initiated by the Storage Commitment SCP server.

A possible sequence of interactions between Storage AE and an Image Manager is illustrated in Figure 3.2.1 on page 22 :

1. The Storage AE opens an association with the Image Manager,
2. Acquired image(s) is transmitted to the Image Manager using a C-STORE request and the Image Manager replies with a C-STORE response (status success),
3. The Storage AE closes the association with the Image Manager,
4. The Storage AE opens an association with the Image Manager,
5. A Store Commitment is requested,
6. The Storage AE closes the association with the Image Manager.

3.2.1.3.2 Proposed Presentation Contexts

Each time an association is initiated, the Association Initiator proposes a number of Presentation Contexts to be used on that association. The Presentation Contexts proposed by Aixplorer for a C-Store service are defined in Table 3.7 on the facing page.

Presentation Context Table					
Abstract Syntax		Transfer Syntax		Role	Extended Negotiation
Name	UID	Name	UID		

Ultrasound Image Storage	1.2.840.10008.5.1.4.1.1.6.1	Implicit VR Little Endian	1.2.840.10008.1.2	SCU	NONE
		Explicit VR Little Endian	1.2.840.10008.1.2.1	SCU	NONE
		Explicit VR Big Endian	1.2.840.10008.1.2.2	SCU	NONE
		JPEG Baseline : Default Transfer Syntax for Lossy JPEG 8 Bit Image Compression	1.2.840.10008.1.2.4.50	SCU	NONE
		JPEG Lossless Compressed	1.2.840.10008.1.2.4.70	SCU	NONE
Ultrasound Multi- Frame Image Storage	1.2.840.10008.5.1.4.1.1.3.1	Implicit VR Little Endian	1.2.840.10008.1.2	SCU	NONE
		Explicit VR Little Endian	1.2.840.10008.1.2.1	SCU	NONE
		Explicit VR Big Endian	1.2.840.10008.1.2.2	SCU	NONE
		JPEG Baseline : Default Transfer Syntax for Lossy JPEG 8 Bit Image Compression	1.2.840.10008.1.2.4.50	SCU	NONE
		JPEG Lossless Compressed	1.2.840.10008.1.2.4.70	SCU	NONE
		MPEG2 Main Profile @ Main Level	1.2.840.10008.1.2.4.100	SCU	NONE
(Retired) Ultrasound Image Storage	1.2.840.10008.5.1.4.1.1.6	Implicit VR Little Endian	1.2.840.10008.1.2	SCU	NONE
		Explicit VR Little Endian	1.2.840.10008.1.2.1	SCU	NONE
		Explicit VR Big Endian	1.2.840.10008.1.2.2	SCU	NONE
		JPEG Baseline : Default Transfer Syntax for Lossy JPEG 8 Bit Image Compression	1.2.840.10008.1.2.4.50	SCU	NONE
		JPEG Lossless Compressed	1.2.840.10008.1.2.4.70	SCU	NONE
(Retired) Ultrasound Multi- Frame Image Storage	1.2.840.10008.5.1.4.1.1.3	Implicit VR Little Endian	1.2.840.10008.1.2	SCU	NONE
		Explicit VR Little Endian	1.2.840.10008.1.2.1	SCU	NONE
		Explicit VR Big Endian	1.2.840.10008.1.2.2	SCU	NONE
		JPEG Baseline : Default Transfer Syntax for Lossy JPEG 8 Bit Image Compression	1.2.840.10008.1.2.4.50	SCU	NONE
		JPEG Lossless Compressed	1.2.840.10008.1.2.4.70	SCU	NONE
		MPEG2 Main Profile @ Main Level	1.2.840.10008.1.2.4.100	SCU	NONE
Encapsulated PDF Storage	1.2.840.10008.5.1.4.1.1.104.1	Implicit VR Little Endian	1.2.840.10008.1.2	SCU	NONE
		Explicit VR Little Endian	1.2.840.10008.1.2.1	SCU	NONE
		Explicit VR Big Endian	1.2.840.10008.1.2.2	SCU	NONE

Table 3.7: Proposed Presentation Contexts for Activity Send instances

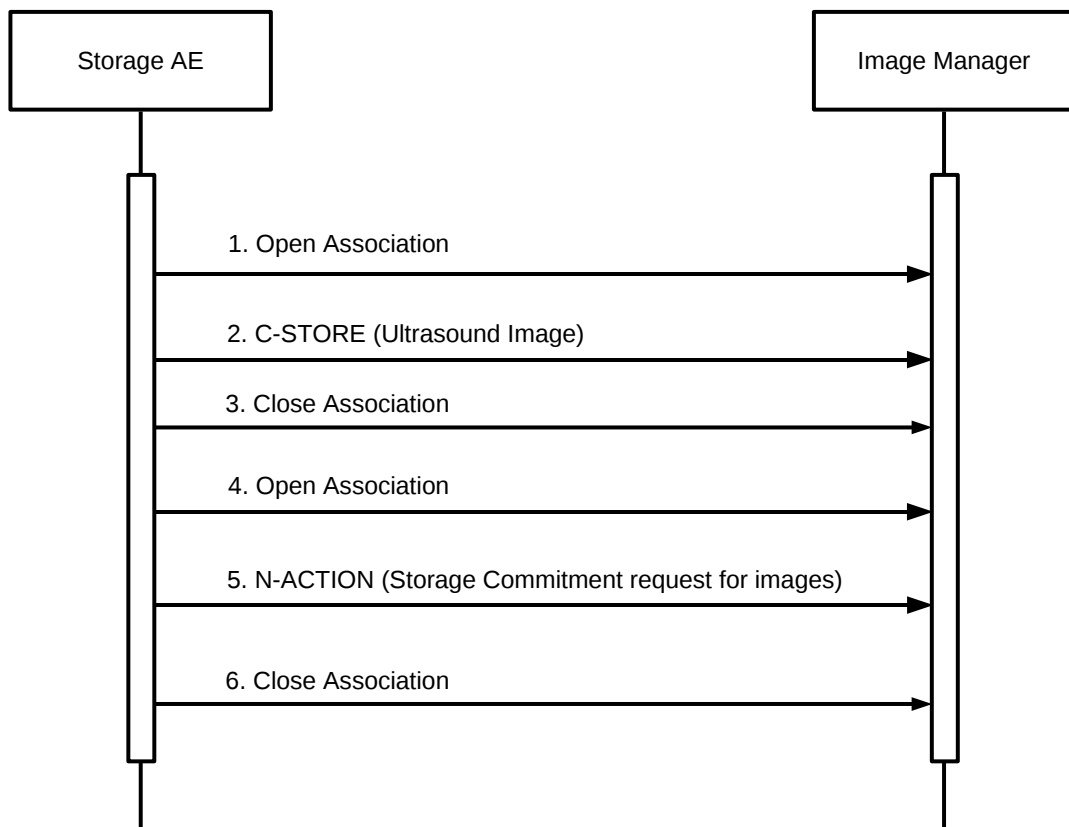

Figure 3.2.1: *Sequencing of Activity - Send Images*

Presentation Contexts for Retired SOP Class will only be proposed if Aixplorer has been configured to send instances with the retired SOP Class. If a remote AE is configured as a Store Commit server, Aixplorer will propose Presentation Contexts as shown in Table 3.8 for the second association.

Presentation Context Table					
Abstract Syntax		Transfer Syntax		Role	Extended Negotiation
Name	UID	Name	UID		
Storage Commitment Push Model	1.2.840.10008.1.20.1	Implicit VR Little Endian	1.2.840.10008.1.2	SCU	NONE
		Explicit VR Little Endian	1.2.840.10008.1.2.1	SCU	NONE

Table 3.8: Proposed Presentation Contexts for AE and Storage Commitment SCU Activity

3.2.1.3.3 SOP Specific Conformance for Storage SOP Class

Aixplorer applies the following rules for its proposed presentation contexts:

- All uncompressed transfer syntaxes are proposed for Storage operations,
- If an image is encoded, its corresponding native transfer syntax is also proposed, and will be preferred by the SCU if both compressed and uncompressed transfer syntaxes are accepted by the SCP,
- If the SCP does not accept encoded transfer syntaxes, Aixplorer will uncompress the related images on the fly.

The DICOM images created by Aixplorer conform to the DICOM IOD definitions (Standard extended IODs). They don't contain any additional private elements.

The DICOM Encapsulated PDF instances created by Aixplorer conform to the DICOM Encapsulated PDF IOD (Standard extended IODs). They don't contain any additional private elements.

Structure of created instances is described in Annex A.1 on page 95.

The behavior of Storage AE when encountering status codes in a C-STORE response is summarized in the Table 3.9 on the next page. A failed Job will be automatically restarted. The delay between resending failed jobs and the number of retries is configurable. If a job keeps failing and reach the number of retries then it will be reschedule at the end of the queue.

The behavior of Storage AE during communication failure is summarized in the Table 3.10 on page 25.

Service Status	Further Meaning	Error Code	Behavior
Success	Success	0000	The SCP has successfully stored the SOP Instance. If all SOP Instances in a send job have status success then the job is marked as complete.
Refused	Out of Resource	A700-A7FF	The Association is aborted using A-ABORT and the send job is marked as failed. The status meaning is logged and the job failure is reported to the user via the job control application. This is a transient failure.
Error	Data Set does not match SOP Class	A900-A9FF	The Association is aborted using A-ABORT and the send job is marked as failed. The status meaning is logged and the job failure is reported to the user via the job control application.
	Cannot Understand	C000-CFFF	The Association is aborted using A-ABORT and the send job is marked as failed. The status meaning is logged and the job failure is reported to the user via the job control application.
Warning	Coercion of Data elements	B000	Image transmission is considered successful but the status meaning is logged.
	Elements Data Set does not match SOP Class	B007	Image transmission is considered successful but the status meaning is logged.
	Elements Discarded	B006	Image transmission is considered successful but the status meaning is logged.
*	*	Any other status code.	The Association is aborted using A-ABORT and the send job is marked as failed. The status code is logged and the job failure is reported to the user via the job control application.

Table 3.9: Storage C-STORE response Status Handling Behavior

Exception	Behavior
Timeout	The Association is aborted using A-ABORT and the send job is marked as failed. The reason is logged and the job failure is reported to the user via the job control interface.
Association aborted by the SCP or network layers	The send job is marked as failed. The reason is logged and the job failure is reported to the user via the job control interface.

Table 3.10: *Storage Communication Failure Behavior*

3.2.1.3.4 SOP Specific Conformance for Storage Commitment SOP Class

3.2.1.3.4.1 Storage Commitment Operations (N-ACTION)

The Storage AE will request storage commitment for encapsulated PDF, US single and multi-frame images if the Remote AE is configured as an archive device with storage commitment facilities and a presentation context for the Storage Commitment Push Model has been accepted. The Storage AE will consider that encapsulated PDF, or US single and multi frame images are not committed until a N-EVENT-REPORT is received for the Transaction UID. The number of committed files per exam is available in “Patient Directory” window. The Storage AE does not send the optional Storage Media FileSet ID & UID attributes or the Referenced Study Component Sequence Attribute in the N-ACTION.

The behavior of Storage AE when encountering status codes in a N-ACTION response is summarized in Table 3.11.

The behavior of Storage AE during communication failure is summarized in Table 3.12 on the following page.

Service Status	Further Meaning	Error Code	Behavior
Success	Success	0000	The request for storage commitment is considered successfully sent.
*	*	Any other status code.	The Association is aborted using A-ABORT and the request for storage commitment is marked as failed. The status meaning is logged and reported to the user.

Table 3.11: *Storage Commitment N-ACTION Response Status Handling Behavior*

Exception	Behavior
Timeout	The Association is aborted using A-ABORT and the send job is marked as failed. The reason is logged and the job failure is reported to the user via the job control application.
Association aborted by the SCP or network layers	The send job is marked as failed. The reason is logged and the job failure is reported to the user via the job control application.

Table 3.12: *Storage Commitment Communication Failure Behavior*

3.2.1.3.4.2 Storage Commitment Notifications (N-EVENT-REPORT)

The Storage AE is capable of receiving a N-EVENT-REPORT notification if it has successfully negotiated a Presentation Context for the Storage Commitment Push Model. However, such notifications are never expected on the same association as the one used to convey the N-ACTION request. The behavior of Storage AE when receiving Event Types within the N-EVENT-REPORT is summarized in Table 3.13 on the next page.

The reasons for returning specific status codes in a N-EVENT-REPORT response are summarized in the Table 3.14 on page 28.

3.2.1.4 Association Acceptance Policy

3.2.1.4.1 Activity - Receive Storage Commitment Response

3.2.1.4.1.1 Description and Sequencing of Activities

When the Storage AE has sent its storage commitment N-ACTION messages to a server, it expects to be notified of responses by N-EVENT-REPORT messages on separate associations. A possible sequence of interactions between Storage AE and an Image Manager is illustrated in Figure 3.2.2 on page 29.

1. The Image Manager opens an association with Storage AE,
2. The Image Manager send the Storage Commitment responses,
3. The Images manager closes the association with the Storage AE.

The Storage AE may reject association attempts as shown in Table 3.15 on page 30. The Result, Source and Reason/Diag columns represent the values returned in the appropriate fields of an ASSOCIATE-RJ PDU (see PS 3.8, Section 9.3.4). The contents of the Source column is abbreviated to save space and the meaning of the abbreviations are:

- a 1 – DICOM UL service-user,

Event Type Name	Event Type ID	Behavior
Storage Commitment Request Successful	1	The Referenced SOP Instances under Referenced SOP Sequence (0008,1199) are marked within the database and PDE window as “Committed” Successfully. Studies with all their instances marked as “Committed” are candidates for “Automatic Deletion after Commit” from the local database. Studies will not be deleted if they are marked with a lock flag.
Storage Commitment Request Complete-Failures Exist	2	The Referenced SOP Instances under Referenced SOP Sequence (0008,1199) are treated in the same way as in the success case (Event Type 1). The Referenced SOP Instances under Failed SOP Sequence (0008,1198) are marked within the database as “Not Committed”. The Failure Reasons are logged and the job failure is reported to the user via the job control application. A send job that failed storage commitment will not be automatically restarted but can be restarted by user interaction.

Table 3.13: *Storage Commitment N-EVENT-REPORT behavior*

Service Status	Further Meaning	Error Code	Reasons
Success	Success	0000	The storage commitment result has been successfully received.
Failure	Unrecognized Operation	0211H	The Transaction UID in the N-EVENT-REPORT request is not recognized (was never issued within a N-ACTION request).
	Resource Limitation	0213H	The Transaction UID in the N-EVENT-REPORT request has expired (no N-EVENT-REPORT was received within a configurable time limit).
	No Such Event Type	0113H	An invalid Event Type ID was supplied in the N-EVENT-REPORT request.
	Processing Failure	0110H	An internal error occurred during processing of the N-EVENT-REPORT. A short description of the error will be returned in Error Comment (0000,0902).
	Invalid Argument Value	0115H	One or more SOP Instance UIDs with the Referenced SOP Sequence (0008,1199) or Failed SOP Sequence (0008,1198) was not included in the Storage Commitment Request associated with this Transaction UID. The unrecognized SOP Instance UIDs will be returned within the Event Information of the N-EVENT-REPORT response.

Table 3.14: *Storage Commitment N-EVENT-REPORT Response Status Reasons*

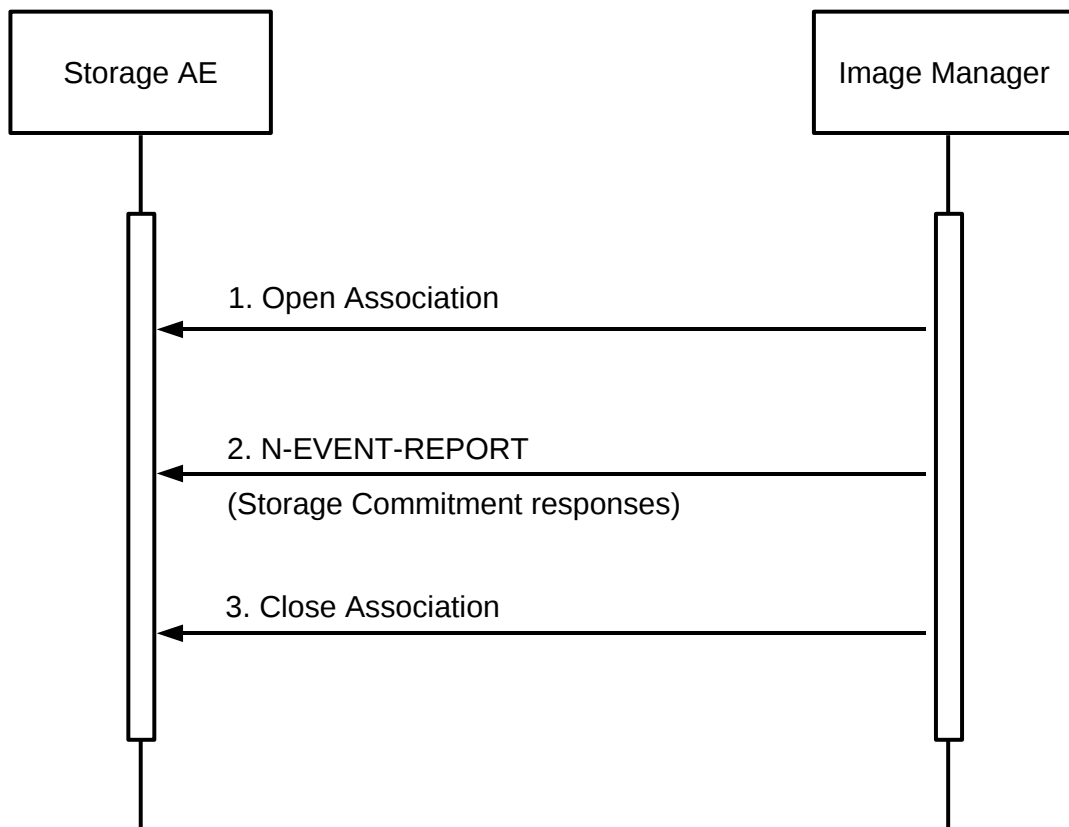

Figure 3.2.2: *Sequencing of Activity - Receive Storage Commitment Response*

- b 2 – DICOM UL service-provider (ASCE related function),
- c 3 – DICOM UL service-provider (Presentation related function).

Result	Source	Reason/Diag	Explanation
2-rejected-transient	c	temporary congestion	No association can be accepted at this time because insufficient resources are available (e.g. memory, processes, threads). An association request with the same parameters may succeed at a later time.
1-rejected-permanent	a	2 - application-context-name-not-supported	The association request contained an unsupported Application Context Name. An association request with the same parameters will not succeed at a later time.
1-rejected-permanent	b	1-no-reason-given	The association request could not be parsed. An association request with the same format will not succeed at a later time.

Table 3.15: Association Rejection Reasons

3.2.1.4.1.2 Accepted Presentation Contexts

The Storage AE will accept Presentation Contexts as shown in Table 3.16.

Presentation Context Table					
Abstract Syntax		Transfer Syntax		Role	Extended Negotiation
Name	UID	Name	UID		
Storage Commitment Push Model	1.2.840.10008.1.20.1	Implicit VR Little Endian	1.2.840.10008.1.2	SCU	NONE
		Explicit VR Little Endian	1.2.840.10008.1.2.1	SCU	NONE
Verification SOP Class	1.2.840.10008.1.1	Implicit VR Little Endian	1.2.840.10008.1.2	SCP	NONE

Table 3.16: Acceptable Presentation Contexts for Activity Receive Storage Commitment Response

3.2.1.4.1.3 SOP Specific Conformance for Storage Commitment SOP Class

3.2.1.4.1.3.1. Storage Commitment Notifications (N-EVENT-REPORT)

Upon receipt of a N-EVENT-REPORT the exam status in the Patient Directory associated with the Transaction UID will be updated.

The behavior of Storage AE when receiving Event Types within the N-EVENT-REPORT is summarized in Table 3.13 on page 27.

The reasons for returning specific status codes in a N-EVENT-REPORT response are summarized in Table 3.14 on page 28.

3.2.1.4.1.3.2. SOP Specific Conformance for Verification SOP Class

The Storage AE provides standard conformance to the Verification SOP Class as a SCP. If the C-ECHO request was successfully received, a 0000 (Success) status code will be returned in the C-ECHO response. Otherwise, a C000 (Error-Cannot Understand) status code will be returned in the C-ECHO response.

3.2.2 Workflow Application Entity Specification

3.2.2.1 SOP Classes

The Workflow AE provides Standard Conformance to the DICOM 3.0 SOP Classes described in Table 3.17.

SOP Class Name	SOP Class UID	SCU	SCP
Modality Worklist Information Model - FIND	1.2.840.10008.5.1.4.31	Yes	No
Modality Performed Procedure Step	1.2.840.10008.3.1.2.3.3	Yes	No

Table 3.17: *SOP Classes for AE Workflow*

3.2.2.2 Association Policies

3.2.2.2.1 General

As illustrated in Table 3.18, the DICOM 3.0 standard Application context is always specified for each association.

Application Context Name	1.2.840.10008.3.1.1.1
--------------------------	-----------------------

Table 3.18: *DICOM Application Context for Workflow AE*

3.2.2.2.2 Number of Associations

The Workflow AE may initiate two Associations at a time (see Table 3.19) :

- One Worklist request,
- One association at a time for a Performed Procedure Step transfer request.

Maximum number of simultaneous Associations	1 Worklist 1 MPPS
---	----------------------

Table 3.19: *Number of Associations as an Association Initiator for Workflow AE*

3.2.2.2.3 Asynchronous Nature

As illustrated in Table 3.20, the Workflow AE does not support asynchronous communication (multiple outstanding transactions over a single Association).

Maximum number of outstanding asynchronous transactions	0
---	---

Table 3.20: *Asynchronous Nature as an Association Initiator for Workflow AE*

3.2.2.2.4 Implementation Identifying Information

The implementation information for the Workflow Application Entity is described in Table 3.21.

Implementation Class UID	1.2.250.1.59.3.0.3.5.3
Implementation Version Name	ETIAM_DCMTK_353

Table 3.21: *DICOM Implementation Class and Version for Workflow AE*

3.2.2.3 Association Initiation Policy

3.2.2.3.1 Activity - Refresh Worklist

3.2.2.3.1.1 Description and Sequencing of Activity

The request for a Worklist Update is initiated by user interaction, *i.e.* pressing the buttons “Update Worklist” or automatically at specific time intervals, configurable by the user. All Modality Worklist operations are performed synchronously and Aixplorer always requests all items. Query for the Scheduled Station AE Title, Scheduled Procedure Step Start Date (actual date, last two days , last seven days), Modality (US) are configurable by a Service Engineer. To protect the system from overflow, Aixplorer can be configured to limit the number of processed Worklist responses to a configurable maximum.

For each basic query of a remote application entity for a Modality Worklist list of items, Aixplorer will initiate an association, send a C-FIND request command, wait in blocking mode for all C-FIND responses, and then release the association. A possible sequence of interactions between the Workflow AE and a Departmental Scheduler (*e.g.* a device such as a RIS or HIS which supports the Modality Worklist SOP Class as a SCP) is illustrated in Figure 3.2.3 on the next page :

1. The Workflow AE opens an association with the Departmental Scheduler;
2. The Workflow AE sends a C-FIND request to the Departmental Scheduler containing the Worklist Query attributes;
3. The Departmental Scheduler returns a C-FIND response containing the requested attributes of the first matching Worklist Item;
4. The Departmental Scheduler returns another C-FIND response containing the requested attributes of the second matching Worklist Item;
5. The Departmental Scheduler returns another C-FIND response with status Success indicating that no further matching; Worklist Items exist. This example assumes that only 2 Worklist items match the Worklist Query;
6. The Workflow AE closes the association with the Departmental Scheduler;
7. The user selects a Worklist Item from the Worklist and prepares to acquire new images.

3.2.2.3.1.2 Proposed Presentation Contexts

Each time an association is initiated, the Association Initiator proposes a number of Presentation Contexts to be used on that association. The Presentation Contexts proposed by Aixplorer for a C-Find service are defined in Table 3.22 on the following page.

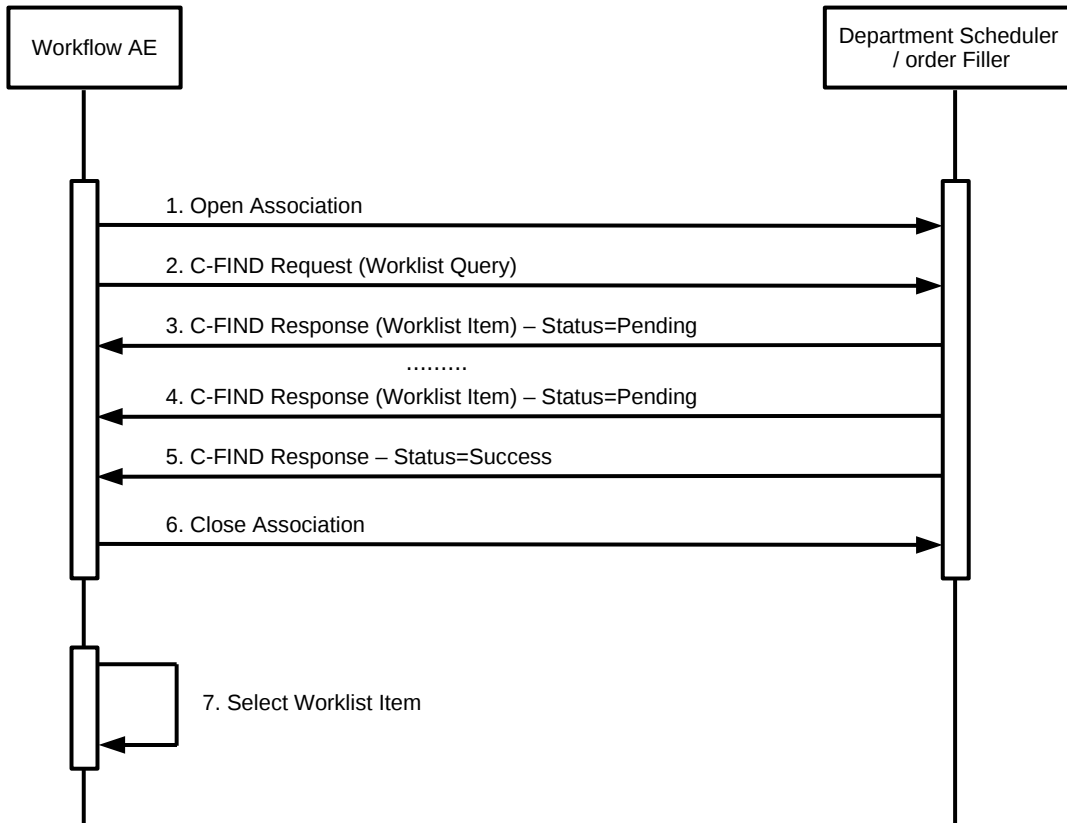

Figure 3.2.3: Sequencing of Activity - Worklist SCU

Presentation Context Table					
Abstract Syntax		Transfer Syntax		Role	Extended Negotiation
Name	UID	Name	UID		
Modality Worklist Information Model	1.2.840.10008.5.1.4.31	Implicit VR Little Endian	1.2.840.10008.1.2	SCU	NONE
		Explicit VR Little Endian	1.2.840.10008.1.2.1	SCU	NONE
		Explicit VR Big Endian	1.2.840.10008.1.2.2	SCU	NONE

Table 3.22: Proposed Presentation Contexts for Workflow AE and Worklist SCU Activity

Service Status	Further Meaning	Error Code	Behavior
Success	Success	0000	The SCP has completed the matches. Worklist items are available for display or further processing.
Refused	Out of Resource	A700	The Association is aborted using A-ABORT and the Worklist query is marked as failed. The status meaning is logged and reported to the user. Any additional error information in the Response will be logged.
Failed	Identifier does not match SOP Class	A900	The Association is aborted using A-ABORT and the Worklist query is marked as failed. The status meaning is logged and reported to the user.
	Unable to Process	CFFF	The Association is aborted using A-ABORT and the Worklist query is marked as failed. The status meaning is logged and reported to the user.
Cancel	Matching terminated due to Cancel request	FE00	If the query was canceled due to too many Worklist items then the SCP has completed the matches. Worklist items are available for display or further processing. Otherwise, the Association is aborted using A-ABORT and the Worklist query is marked as failed. The status meaning is logged.
Pending	Matches are continuing	FF00	The Worklist item contained in the Identifier is collected for later display.
	Matches are continuing – Warning that one or more Optional Keys were not supported	FF01	The Worklist item contained in the Identifier is collected for later display or further processing. The status meaning is logged only once for each C-FIND operation.
*	*	Any other status code.	The Association is aborted using A-ABORT and the Worklist is marked as failed. The status meaning is logged and reported to the user. Any additional error information in the Response will be logged.

Table 3.23: Modality Worklist C-FIND response status handling behavior

3.2.2.3.1.3 Specific Conformance for Worklist Management SOP Class

The behavior of Aixplorer when encountering status codes in a Modality Worklist C-FIND response is summarized in Table 3.23 on page 39. If any other SCP response status than “Success” or “Pending” is received by Aixplorer, a notification will appear on the user interface.

The behavior of Aixplorer during communication failure is summarized in Table 3.24 on page 40.

Exception	Behavior
Timeout	The Association is aborted using A-ABORT and the Worklist query marked as failed. The reason is logged and reported to the user if an interactive query.
Association aborted by the SCP or network layers	The Worklist query is marked as failed. The reason is logged and reported to the user.

Table 3.24: *Modality Worklist Communication Failure Behavior*

Acquired images will always¹ use the Study Instance UID specified for the Scheduled Procedure Step (if available). If an acquisition is unscheduled, a Study Instance UID will be generated locally. Table 3.25 on page 37 below provides a description of Aixplorer Worklist Request Identifier and specifies the attributes that are copied into the images. Unexpected attributes returned in a C-FIND response are ignored. Requested return attributes not supported by the SCP are set to have no value. Non-matching responses returned by the SCP due to unsupported optional matching keys are ignored. No attempt is made to filter out possible duplicate entries.

Module Name Attribute Name	Tag	VR	VM	M	R	Q	D	IOD
SOP Common Specific Character Set	(0008,0005)	CS	1-n		x			
Scheduled Procedure Step								
Scheduled Procedure Step Sequence	(0040,0100)	SQ	1		x			
> Scheduled Station AET	(0040,0001)	AE	1-n	S			x	
> Scheduled Procedure Step Start Date	(0040,0002)	DA	1	R			x	
> Scheduled Procedure Step Start Time	(0040,0003)	TM	1		x		x	
> Scheduled Procedure Step End Date	(0040,0004)	DA	1		x		x	
> Scheduled Procedure Step End Time	(0040,0005)	TM	1		x		x	
> Modality	(0008,0060)	CS	1	S	x		x	x
> Scheduled Performing Physician's Name	(0040,0006)	PN	1		x		x	x

¹Except if UID is not valid or DICOM administrator setting forced.

> Scheduled Procedure Step Description	(0040,0007)	LO	1		x		x	x
> Scheduled Station Name	(0040,0010)	SH	1-n		x		x	x
> Scheduled Procedure Step Location	(0040,0011)	SH	1		x		x	x
> Scheduled Protocol Code Sequence	(0040,0008)	SQ	1-n		x		x	x
» Code Value	(0008,0100)	SH	1		x		x	x
» Coding Scheme Designator	(0008,0102)	SH	1		x		x	x
» Coding Scheme Version	(0008,0103)	SH	1		x		x	x
» Code Meaning	(0008,0104)	LO	1		x		x	x
> Pre-Medication	(0040,0012)	LO	1		x		x	
> Scheduled Procedure Step ID	(0040,0009)	SH	1		x		x	x
> Requested Contrast Agent	(0032,1070)	LO	1		x		x	
> Scheduled Procedure Step status	(0040,0020)	CS	1		x		x	
> Comments on the Scheduled Procedure Step	(0040,0400)	LT	1		x		x	
Requested Procedure								
Requested Procedure ID	(0040,1001)	SH	1		x		x	x
Requested Procedure Description	(0032,1060)	LO	1		x		x	x
Reason for the Requested Procedure	(0040,1002)	LO	1		x		x	
Study Instance UID	(0020,000D)	UI	1		x		x	x
Referenced Study Sequence	(0008,1110)	SQ	1		x		x	x
> Referenced SOP Class UID	(0008,1150)	UI	1		x		x	x
> Referenced SOP Instance UID	(0008,1155)	UI	1		x		x	x
Requested Procedure Priority	(0040,1003)	SH	1		x		x	
Patient Transport Arrangements	(0040,1004)	LO	1		x		x	
Requested Procedure Code Sequence	(0032,1064)	SQ	1		x		x	x
> Code Value	(0008,0100)	SH	1		x		x	x
> Coding Scheme Designator	(0008,0102)	SH	1		x		x	x
> Coding Scheme Version	(0008,0103)	SH	1		x		x	x
> Code Meaning	(0008,0104)	LO	1		x		x	x
Names of intended recipients of results	(0040,1010)	PN	1-n		x		x	x
Requested Procedure Comments	(0040,1400)	LT	1		x		x	x
Imaging Service Request								
Accession Number	(0008,0050)	SH	1		x		x	x
Requesting Physician	(0032,1032)	PN	1		x		x	x
Referring Physician's Name	(0008,0090)	PN	1		x		x	x
Requesting Service	(0032,1033)	LO	1		x		x	
Reason for the Imaging Service Request (RET)	(0040,2001)	LO	1		x		x	
Imaging service request comments	(0040,2400)	LT	1		x		x	

Placer Order number/imaging service request	(0040,2016)	LO	1		x		x	
Visit Identification								
Admission ID	(0038,0010)	LO	1		x		x	
Visit Status								
Current Patient Location	(0038,0300)	LO	1		x		x	
Visit Relationship								
Referenced Patient Sequence	(0008,1120)	SQ	1		x		x	x
> Referenced SOP Class UID	(0008,1150)	UI	1		x		x	x
> Referenced SOP Instance UID	(0008,1155)	UI	1		x		x	x
Patient Identification								
Patient Name	(0010,0010)	PN	1	*	x		x	x
Patient ID	(0010,0020)	LO	1		x		x	x
Issuer of Patient ID	(0010,0021)	LO	1		x		x	x
Other Patient IDs	(0010,1000)	LO	1-n		x		x	x
Patient Demographic								
Patient's Birth Date	(0010,0030)	DA	1		x		x	x
Patient's Birth time	(0010,0032)	TM	1		x		x	x
Patient's Sex	(0010,0040)	CS	1		x		x	x
Patient's Weight	(0010,1030)	DS	1		x		x	x
Patient's Size	(0010,1020)	DS	1		x		x	x
Confidentiality constraint on patient data	(0040,3001)	LO	1		x		x	
Patient comments	(0010,4000)	LT	1		x		x	x
Ethnic Group	(0010,2160)	SH	1		x		x	x
Patient Medical								
Patient State	(0038,0500)	LO	1		x		x	
Pregnancy Status	(0010,21C0)	US	1		x		x	
Medical Alerts	(0010,2000)	LO	1-n		x		x	
Allergies	(0010,2110)	LO	1-n		x		x	
Special Needs	(0038,0050)	LO	1		x		x	
Additional patient History	(0010,21B0)	LT	1		x		x	
Last Menstrual Date	(0010,21D0)	DA	1		x		x	

Table 3.25: Worklist Request Identifier

Table 3.25 should be read as follows:

- Module Name: The name of the associated module for supported worklist attributes.
- Attribute Name: Attributes supported to build an Aixplorer Worklist Request Identifier.
- Tag: DICOM tag for this attribute.
- VR: DICOM VR for this attribute.
- VM: DICOM VM for this attribute.

- M:** Matching keys for Worklist Update. A “S” will indicate that Aixplorer will supply an attribute value for Single Value Matching, a “R” will indicate Range Matching and a “*” will denote wildcard matching.
- R:** Return keys. An “x” will indicate that Aixplorer will supply this attribute as Return Key with zero length for Universal Matching. The Aixplorer will support retired date format (yyyy.mm.dd) for “Patient’s Birth Date” and “Scheduled Procedure Step Start Date” in the response identifiers. For “Scheduled Procedure Step Start Time” also retired time format as well as unspecified time components are supported.
- Q:** Interactive Query Key.
- D:** Displayed keys. An “x” indicates that this Worklist attribute is displayed to the user during a patient registration dialog. For example, Patient Name will be displayed when registering the patient prior to an examination.
- IOD:** An “x” indicates that this Worklist attribute is included into all Object Instances created during performance of the related Procedure Step.

The default Query Configuration is set to all Worklist items. Optionally, additional matching for the own AET, US modality², and a period of time is configurable.

3.2.2.3.2 Activity - Acquire images

3.2.2.3.2.1 Description and Sequencing of Activities

After Patient registration, Aixplorer is awaiting the first image acquisition. The trigger to create a MPPS SOP Instance is derived from this event. An Association to the configured MPPS SCP system is established immediately and the related MPPS SOP Instance will be created. The final state of the MPPS is automatically set to:

- “COMPLETED” when user close the exam by either pressing the “End of Exam” button on the control panel or by pressing “new patient” on the touch screen.
- “DISCONTINUED” when user press the “Cancel Exam” button on the touch screen. In the “Discontinued” case, the discontinuation reason is automatically set to “Doctor cancel procedure” or “equipment failure”.

Aixplorer only supports a 0-to-1 relationship between Scheduled and Performed Procedure Steps. Aixplorer initiates an Association to issue both :

- a N-CREATE request according to the CREATE Modality Performed Procedure Step SOP Instance operation;

²Modality value can be adjusted by a DICOM administrator

- a N-SET request to update the contents and state of the MPPS according to the SET Modality Performed Procedure Step Information operation.

A possible sequence of interactions between the Workflow AE and a Departmental Scheduler (e.g. a device such as a RIS or HIS which supports the MPPS SOP Class as a SCP) is illustrated in Figure 3.2.4 on page 41:

1. The Workflow AE opens an association with the Departmental Scheduler;
2. The Workflow AE sends a N-CREATE request to the Departmental Scheduler to create an MPPS instance with status of “IN PROGRESS” and create all necessary attributes. The Departmental Scheduler acknowledges the MPPS creation with a N-CREATE response (status success);
3. The Workflow AE closes the association with the Departmental Scheduler;
4. All images are acquired and stored in the local database;
5. The Workflow AE opens an association with the Departmental Scheduler;
6. The Workflow AE sends a N-SET request to the Departmental Scheduler to update the MPPS instance with status of “COMPLETED” and set all necessary attributes. The Departmental Scheduler acknowledges the MPPS update with a N-SET response (status success);
7. The Workflow AE closes the association with the Departmental Scheduler.

3.2.2.3.2.2 Proposed Presentation Contexts

The Workflow AE will propose Presentation Contexts as shown in Table 3.27.

Presentation Context Table					
Abstract Syntax		Transfer Syntax		Role	Extended Negotiation
Name	UID	Name	UID		
Modality Performed Procedure Step	1.2.840.10008.3.1.2.3.3	Implicit VR Little Endian	1.2.840.10008.1.2	SCU	NONE
		Explicit VR Little Endian	1.2.840.10008.1.2.1	SCU	NONE
		Explicit VR Big Endian	1.2.840.10008.1.2.2	SCU	NONE

Table 3.27: Proposed Presentation Contexts for Workflow AE and MPPS SCU Activity

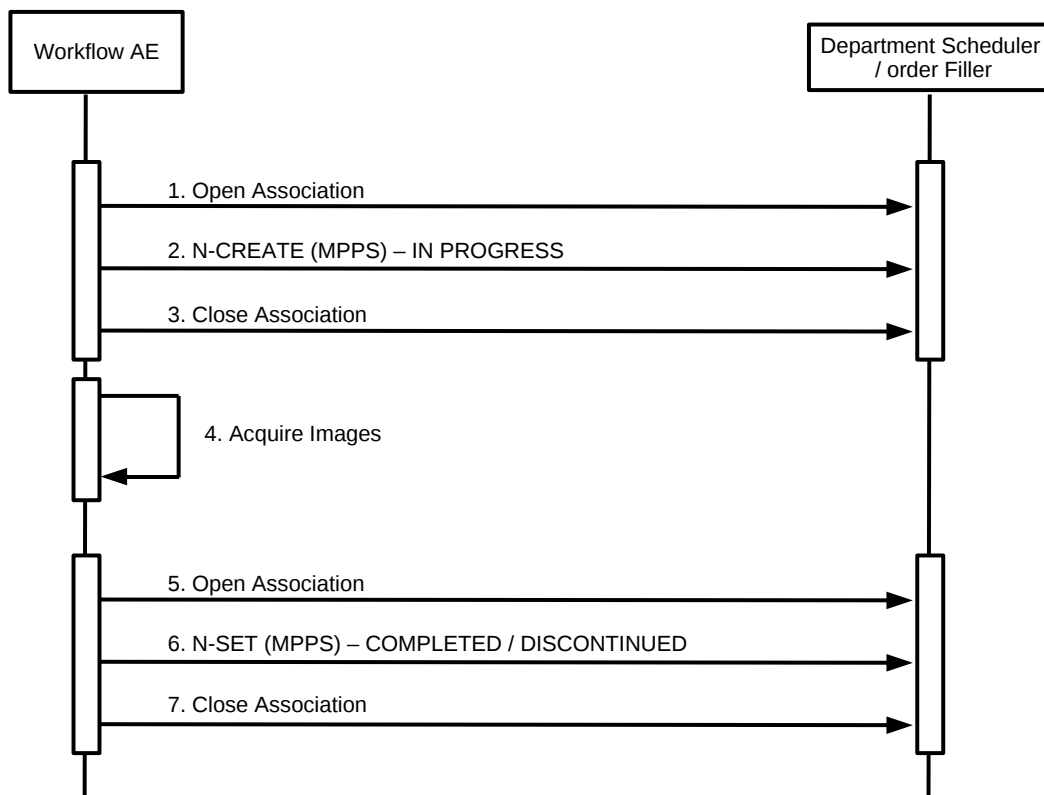

Figure 3.2.4: *Sequencing of Activity - MPPS SCU*

3.2.2.3.2.3 Specific Conformance for MPPS SOP Class

The behavior of Aixplorer when encountering status codes in an MPPS N-CREATE or N-SET response is summarized in Table 3.28 on page 42. If any other SCP response status than “Success” or “Warning” is received by Aixplorer, a notification will appear on the user interface.

Service Status	Further Meaning	Error Code	Behavior
Success	Success	0000	The SCP has completed the operation successfully.
Failure	Processing Failure – Performed Procedure Step Object may no longer be updated	0110	The Association is aborted using A-ABORT and the MPPS is marked as failed. The status meaning is logged and reported to the user.
Warning	Attribute Value Out of Range	0116H	The MPPS operation is considered successful but the status meaning is logged.
*	*	Any other status code.	The Association is aborted using A-ABORT and the MPPS is marked as failed. The status meaning is logged and reported to the user.

Table 3.28: MPPS N-CREATE / N-SET Response Status Handling Behavior

The behavior of Workflow AE during communication failure is summarized in Table 3.29 on page 42.

Exception	Behavior
Timeout	The Association is aborted using A-ABORT and MPPS marked as failed. The reason is logged and reported to the user.
Association aborted by the SCP or network layers	The MPPS is marked as failed. The reason is logged and reported to the user.

Table 3.29: MPPS Communication Failure Behavior

Table 3.30 on page 46 provides a description of the MPPS N-CREATE and N-SET request identifiers sent by Aixplorer. Empty cells in the N-CREATE and N-SET columns indicate that the attribute is not sent. An “x” indicates that an appropriate value will be sent. A “Zero length” attribute will be sent with zero length.

Attribute Name	Tag	VR	N-CREATE	N-SET
Specific Character set	(0008,0005)	CS	see Table 5.1 on page 90	
Performed Procedure Step Relationship				
Scheduled Step Attributes Sequence	(0040,0270)	SQ		
> Study Instance UID	(0020,000D)	UI	From Modality Worklist	
> Referenced Study Sequence	(0008,1110)	SQ	From Modality Worklist	
» Referenced SOP Class UID	(0008,1150)	UI		
» Referenced SOP Instance UID	(0008,1155)	UI		
> Accession Number	(0008,0050)	SH	From Modality Worklist or user input. The user can't modify values provided via Modality Worklist.	
> Placer Order Number / Imaging Service Request	(0040,0026)	SH	From Modality Worklist or not send.	
> Requested Procedure ID	(0040,1001)	SH	From Modality Worklist	
> Requested Procedure Code Sequence	(0032,1064)	SQ	From Modality Worklist	
> Requested Procedure Description	(0032,1060)	LO	From Modality Worklist	
> Scheduled Procedure Step ID	(0040,0009)	SH	From Modality Worklist	
> Scheduled Procedure Step Description	(0040,0007)	LO	From Modality Worklist	
> Scheduled Protocol Code Sequence	(0040,0008)	SQ	From Modality Worklist	
Patient's Name	(0010,0010)	PN	From Modality Worklist or user input. The user can't modify values provided via Modality Worklist.	
Patient ID	(0010,0020)	LO	From Modality Worklist or user input. The user can't modify values provided via Modality Worklist.	

Issuer Of Patient ID	(0010,0021)	LO	From Modality Worklist or empty. The user can't modify values provided via Modality Worklist.	
Patient's Birth Date	(0010,0030)	DA	From Modality Worklist or user input. The user can modify values provided via Modality Worklist.	
Patient's Sex	(0010,0040)	CS	From Modality Worklist or user input. The user can modify values provided via Modality Worklist.	
Referenced Patient Sequence	(0008,1120)	SQ	From Modality Worklist or zero length. The user can modify values provided via Modality Worklist.	
Admission ID	(0038,0010)	LO	From Modality Worklist.	
Performed Procedure Step Information				
Performed Procedure Step ID	(0040,0253)	SH	Automatically created but can be modified by the user. From Modality Worklist or user input.	
Performed Station AE Title	(0040,0241)	AE	Aixplorer AE Title	
Performed Station Name	(0040,0242)	SH	From configuration	
Performed Location	(0040,0243)	SH	From configuration	
Performed Procedure Step Start Date	(0040,0244)	DA	Actual start date	
Performed Procedure Step Start Time	(0040,0245)	TM	Actual start time	
Performed Procedure Step Description	(0040,0254)	LO	Use Study Description Value.	
Performed Procedure Type Description	(0040,0255)	LO	Zero length	
Procedure Code Sequence	(0008,1032)	SQ	Copy from Requested Code Sequence (0032,1064)	
Performed Procedure Step End Date	(0040,0250)	DA	Zero length	Actual end date

Performed Procedure Step End Time	(0040,0251)	TM	Zero length	Actual end time
Performed Procedure Step Status	(0040,0252)	CS	IN PROGRESS	DISCONTINUED or COMPLETED
Comments On The Performed Procedure Step	0040,0280	ST	Copy from Comments on the Scheduled Procedure Step (0040,0400) if provided by Modality Worklist.	
Performed Procedure Step Discontinuation Reason Code Sequence	(0040,0281)	SQ	Zero length	If Performed Procedure Step Status (0040,0252) is "DISCONTINUED" then a single item will be present containing an entry drawn from Context Group 9300.

Image Acquisition Results

Modality	(0008,0060)	CS	US	
Study ID	(0020,0010)	SH	From Modality Worklist or From Modality Worklist or user input. The user can modify values provided via Modality Worklist.	
Performed Protocol Code Sequence	(0040,0260)	SQ	Zero length	
Performed Series Sequence	(0040,0340)	SQ	Zero length	
> Performing Physician's Name	(0008,1050)	PN		From Modality Worklist or user input. The user can't modify values provided via Modality Worklist.
> Operator's Name	(0008,1070)	PN		From Modality Worklist or user input. The user can't modify values provided via Modality Worklist.
> Protocol Name	(0018,1030)	LO		"Free From"
> Series Instance UID	(0020,000E)	UI		x
> Series Description	(0008,103E)	LO		x
> Retrieve AE Title	(0008,0054)	AE		From Configuration

> Archive Requested	(0040,A494)	CS		x
> Referenced Image Sequence	(0008,1140)	SQ		One or more items
» Referenced SOP Class UID	(0008,1150)	UI		x
» Referenced SOP Instance UID	(0008,1155)	UI		x
> Referenced Non Image Composite SOP Instance Sequence	(0008,1140)	SQ		Zero or One item
» Referenced SOP Class UID	(0008,1150)	UI		x
» Referenced SOP Instance UID	(0008,1155)	UI		x

Table 3.30: *MPPS N-Create / N-Set Request Identifier*

3.2.2.4 Association Acceptance Policy

The Workflow AE does not accept Associations.

3.2.3 Hardcopy Application Entity Specification

3.2.3.1 SOP Classes

The Hardcopy AE provides Standard Conformance to the DICOM 3.0 SOP Classes described in Table 3.31 on the next page.

3.2.3.2 Association Policies

3.2.3.2.1 General

As illustrated in Table 3.32 on the facing page, the DICOM 3.0 standard Application context is always specified for each association.

3.2.3.2.2 Number of Associations

Hardcopy AE may initiates 1 Association at a time (see Table 3.33).

3.2.3.2.3 Asynchronous Nature

As illusted in Table 3.34, Hardcopy AE does not support asynchronous communication (multiple outstanding transactions over a single Association).

SOP Class Name	SOP Class UID	SCU	SCP
Supported Meta SOP Classes for Basic Print Service			
Basic Grayscale Print Management	1.2.840.10008.5.1.1.9	Yes	No
Basic Color Print Management	1.2.840.10008.5.1.1.18	Yes	No
Supported SOP Classes for Basic Grayscale Print Service			
Basic Film Session SOP Class	1.2.840.10008.5.1.1.1	Yes	No
Basic Film Box SOP Class	1.2.840.10008.5.1.1.2	Yes	No
Basic Grayscale Image Box SOP Class	1.2.840.10008.5.1.1.4	Yes	No
Printer SOP Class	1.2.840.10008.5.1.1.16	Yes	No
Supported SOP Classes for Basic Color Print Service			
Basic Film Session SOP Class	1.2.840.10008.5.1.1.1	Yes	No
Basic Film Box SOP Class	1.2.840.10008.5.1.1.2	Yes	No
Basic Color Image Box SOP Class	1.2.840.10008.5.1.1.4.1	Yes	No
Printer SOP Class	1.2.840.10008.5.1.1.16	Yes	No

Table 3.31: *SOP Classes for AE Hardcopy*

Application Context Name	1.2.840.10008.3.1.1.1
--------------------------	-----------------------

Table 3.32: *DICOM Application Context for Hardcopy AE*

Maximum number of simultaneous Associations	1
---	---

Table 3.33: *Number of Associations as an Association Initiator for Hardcopy AE*

Maximum number of outstanding asynchronous transactions	0
---	---

Table 3.34: *Asynchronous Nature as an Association Initiator for Hardcopy AE*

3.2.3.2.4 Implementation Identifying Information

The implementation information for the Hardcopy Application Entity is described in Table 3.35.

Implementation Class UID	1.2.250.1.59.3.0.3.5.3
Implementation Version Name	ETIAM_DCMTK_353

Table 3.35: DICOM Implementation Class and Version for Hardcopy AE

3.2.3.3 Association Initiation Policy

3.2.3.3.1 Activity - print images

3.2.3.3.1.1 Description and Sequencing of Activity

Aixplorer will initiate a separate association with a Print SCP for each print session. After an association has been accepted and is established, Aixplorer will send a print job to the Print Server. Each print job includes the following steps (see Figure 3.2.5 on the facing page):

- Aixplorer first performs a N-GET request to get Printer information;
- Aixplorer requests the server to a N-CREATE a film session SOP instance.

For each film to be printed:

- A N-CREATE request is performed to get a Film Box SOP instance;
- N-SET requests are made to change some film box instance attributes and to fill image boxes with image pixel data;
- If no print collation is needed, a N-ACTION is requested for the Film Box instance;
- This causes the film to be printed;
- If print collation is requested, a N-ACTION is performed on the film session.

3.2.3.3.1.2 Proposed Presentation Contexts

Aixplorer will propose Presentation Contexts as shown in Table 3.36 on the next page.

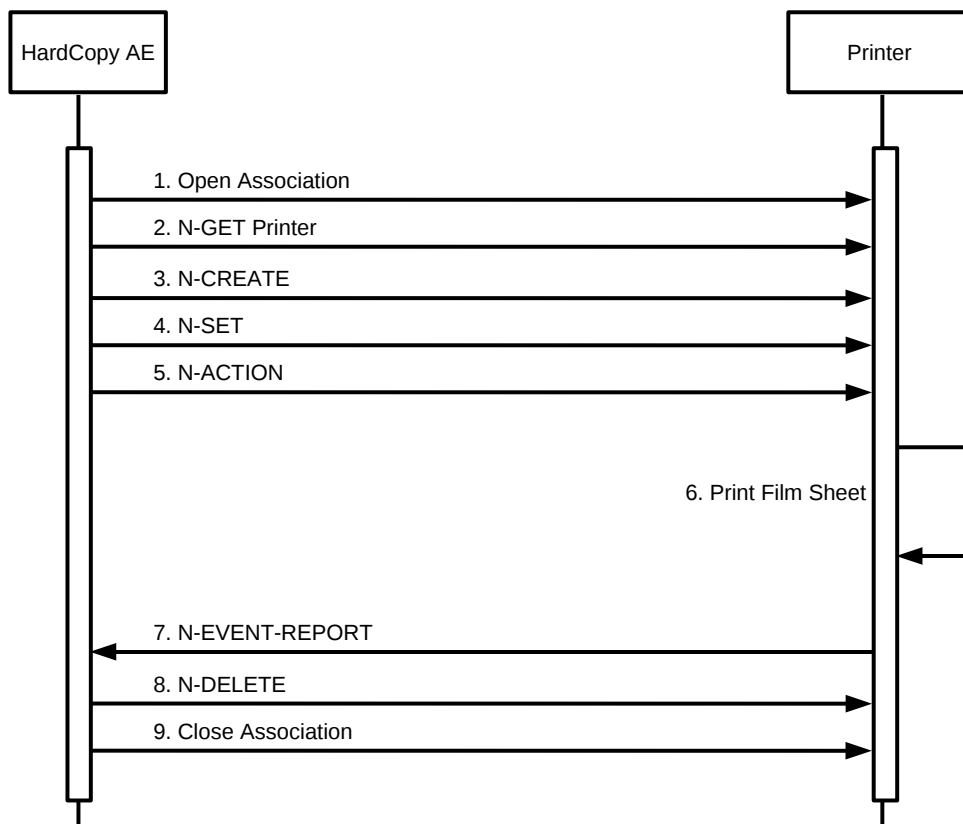

Figure 3.2.5: Sequencing of Activity - Print SCU

Presentation Context Table					
Abstract Syntax		Transfer Syntax		Role	Extended Negotiation
Name	UID	Name	UID		
Basic Grayscale Print Management Meta SOP Class ¹	1.2.840.10008.5.1.1.9	Implicit VR Little Endian	1.2.840.10008.1.2	SCU	NONE
		Explicit VR Little Endian	1.2.840.10008.1.2.1	SCU	NONE
		Explicit VR Big Endian	1.2.840.10008.1.2.2	SCU	NONE
Basic Color Print Management Meta SOP Class ¹	1.2.840.10008.5.1.1.18	Implicit VR Little Endian	1.2.840.10008.1.2	SCU	NONE
		Explicit VR Little Endian	1.2.840.10008.1.2.1	SCU	NONE
		Explicit VR Big Endian	1.2.840.10008.1.2.2	SCU	NONE

¹Only one Abstract Syntax is proposed. Choice is achieved through configuration window.

Table 3.36: Proposed Presentation Contexts for Hardcopy AE and Print SCU Activity

3.2.3.3.1.3 SOP Specific Conformance for Print SOP Class

If the DICOM Print software is unable to open an association with the selected destination AE, an error message displays in Aixplorer. No message is displayed when successful printing operation responses are received. After an association has been accepted and is established, Aixplorer will send a print job to the Print Server. Each print job includes the following steps:

- Aixplorer first performs a N-GET request to get Printer information;
- Aixplorer requests the server to a N-CREATE a film session SOP instance;
- For each film to be printed:
 - A N-CREATE request is performed to get a Film Box SOP instance;
 - N-SET requests are made to change some film box instance attributes and to fill image boxes with image pixel data;
 - If no print collation is needed, a N-ACTION is requested for the Film Box instance. This causes the film to be printed;
 - If print collation is requested, a N-ACTION is performed on the film session.

3.2.3.3.1.3.1. Basic Printer SOP Class

Aixplorer can send the following DIMSE commands to a Film Box: N-GET. N-GET is issued by Aixplorer to get Print information. However, this information is not used.

3.2.3.3.1.3.2. Basic Film Session SOP Class

Aixplorer can send the following DIMSE commands to a Film Session: N-CREATE, N-SET, N-ACTION, N-DELETE.

- N-CREATE is issued by Aixplorer to create a Film Session where film boxes will be created. (see Table 3.37):

Attribute Name	Tag ID	Value / Comment
Number of Copies	(2000, 0010)	Default is 1

Table 3.37: *Number of Copies for Basic Film Session*

- N-SET is issued by Aixplorer to change Film Session attributes (see Table 3.38);
- N-ACTION is issued by Aixplorer to request printing of all Film Boxes in the Film Session;
- N-DELETE is issued by Aixplorer to request a Film Session deletion;

Attribute Name	Tag ID	Value / Comment
Number of Copies	(2000,0010)	Default is 1
Print Priority	(2000,0020)	HIGH, MED, LOW. Default is MED
Medium Type	(2000,0030)	PAPER, BLUE FILM, CLEAR FILM or empty string. Default is paper
Film Destination	(2000,0040)	PROCESSOR or MAGAZINE. Default is MAGAZINE
Film Session Label	(2000,0050)	Configurable

Table 3.38: Basic Film Session SOP Class N-CREATE request attributes

3.2.3.3.1.3.3. Basic Film Box SOP Class

Aixplorer can send the following DIMSE commands to a Film Box: N-CREATE, N-SET, N-ACTION, N-DELETE.

- N-CREATE is issued by Aixplorer to create a Film Box in a Film Session, where image boxes will be created (see Table 3.39 on the following page);

Attribute Name	Tag ID	Value / Comment
Image Display Format	(2010,0010)	STANDARD
Film Orientation	(2010,0030)	PORTRAIT or LANDSCAPE. Default is PORTRAIT.

Table 3.39: Basic Film Box SOP Class N-CREATE attributes

- N-SET is issued by Aixplorer to create change Film Box attributes (see Table 3.40 on the preceding page);
- N-ACTION is issued by Aixplorer to request printing of a Film Boxes;
- N-DELETE is issued by Aixplorer to request a Film Box deletion;

3.2.3.3.1.3.4. Basic Grayscale Image Box SOP Class

Basic Grayscale Image Box instances are created at the time the Basic Film Box SOP instance is created. The Basic Image Box contains the presentation parameters and image pixel data that apply to a single image of a film sheet. Aixplorer can send the following DIMSE commands to an Image Box: N-SET.

- N-SET is issued by Aixplorer to set change Image Box attributes. (see Table 3.41).

Attribute Name	Tag ID	Value / Comment
Image Display Format	(2010, 0010)	STANDARD
Film Orientation	(2010, 0030)	PORTRAIT or LANDSCAPE. Default is PORTRAIT.
Film Size ID	(2010, 0050)	8INX10IN, 8_5INX11IN, 10INX12IN, 10INX14IN, 11INX14IN, 14INX14IN, 14INX17IN, 24CMX24CM, 24CMX30CM, A4 or A3. Not set if default.
Magnification Type	(2010, 0060)	NONE, REPLICATE, BILINEAR or CUBIC Not set if default.
Smoothing Type	(2010, 0080)	Not set if default.
Border Density	(2010, 0100)	BLACK, WHITE, Grayscale. Not set if default
Empty Image Density	(2010, 0110)	BLACK, WHITE, Grayscale. Not set if default
Min Density	(2010, 0120)	Not set
Max Density	(2010, 0130)	Not set
Trim	(2010, 0140)	Not set
Referenced Film Session Sequence	(2010, 0500)	
>Referenced SOP Class UID	(0008, 1150)	
>Referenced SOP Instance UID	(0008, 1155)	

Table 3.40: Basic Film Box SOP Class N-SET attributes

Attribute Name	Tag ID	Value / Comment
Image Position	(2020, 0010)	1 to <number of images in film box>
Polarity	(2020, 0020)	NORMAL or REVERSE. Not set if default
Basic Grayscale Image Sequence	(2020, 0110)	
>Samples Per Pixel	(0028, 0002)	1
>Photometric Interpretation	(0028, 0004)	MONOCHROME2
>Rows	(0028, 0010)	
>Columns	(0028, 0011)	
>Pixel Aspect Ratio	(0028, 0034)	1
>Bits Allocated	(0028, 0100)	16
>Bits Stored	(0028, 0101)	12
>High Bit	(0028, 0102)	11
>Pixel Representation	(0028, 0103)	0
>Pixel Data	(7FE0, 0010)	

Table 3.41: Basic Grayscale Image Box SOP Class Request attributes

3.2.3.3.1.3.5. Basic Color Image Box SOP Class

Basic Color Image Box instances are created at the time the Basic Film Box SOP instance is created. The Basic Image Box contains the presentation parameters and image pixel data that apply to a single image of a film sheet. Aixplorer can send the following DIMSE commands to an Image Box: N-SET.

- N-SET is issued by Aixplorer to set change Image Box attributes. (see Table 3.42)

3.2.4 Verification Application Entity Specification

3.2.4.1 SOP Classes

The Verification AE provides Standard Conformance to the DICOM 3.0 SOP Classes described in Table 3.43.

3.2.4.2 Association Policies

3.2.4.2.1 General

As illustrated in Table 3.44 on the next page, the DICOM 3.0 standard Application context is always specified for each association.

Attribute Name	Tag ID	Value / Comment
Image Position	(2020, 0010)	1 to <number of images in film box>
Polarity	(2020, 0020)	NORMAL or REVERSE. Not set if default.
Basic Color Image Sequence	(2020, 0110)	
>Samples Per Pixel	(0028, 0002)	3
>Photometric Interpretation	(0028, 0004)	RGB
>Planar Configuration	(0028, 0006)	0
>Rows	(0028, 0010)	
>Columns	(0028, 0011)	
>Pixel Aspect Ratio	(0028, 0034)	1
>Bits Allocated	(0028, 0100)	8
>Bits Stored	(0028, 0101)	8
>High Bit	(0028, 0102)	7
>Pixel Representation	(0028, 0103)	0
>Pixel Data	(7FE0, 0010)	

Table 3.42: Basic Color Image Box SOP Class Request attributes

SOP Class Name	SOP Class UID	SCU	SCP
Verification	1.2.840.10008.1.1	Yes	No

Table 3.43: SOP Classes for AE Verification

Application Context Name	1.2.840.10008.3.1.1.1
--------------------------	-----------------------

Table 3.44: DICOM Application Context for Verification AE

3.2.4.2.2 Number of Associations

Verification AE may initiate 1 Association at a time (see Table 3.45).

Maximum number of simultaneous Associations	1
---	---

Table 3.45: *Number of Associations as an Association Initiator for Verification AE*

3.2.4.2.3 Asynchronous Nature

As illustrated in Table 3.46, Verification AE does not support asynchronous communication (multiple outstanding transactions over a single Association).

Maximum number of outstanding asynchronous transactions	0
---	---

Table 3.46: *Asynchronous Nature as an Association Initiator for Verification AE*

3.2.4.2.4 Implementation Identifying Information

The implementation information for the Verification Application Entity is described in Table 3.47 on the following page.

Implementation Class UID	Implementation Version Name
1.2.250.1.59.3.0.3.5.3	ETIAM_DCMTK_353
1.2.250.1.204.0.1.20100608.0.3.5.5	SSI_DCMTK_355

Table 3.47: *DICOM Implementation Class and Version for Verification AE*

3.2.4.3 Association Initiation Policy

3.2.4.3.1 Activity - Verification SCU

3.2.4.3.1.1 Description and Sequencing of Activities

All verification SCU operations are performed synchronously, on user request. Aixplorer may initiate an association with a Verification SCP within its configuration panel to check remote SCP availability. A possible sequence of interactions between Verification SCU and a verification SCP is illustrated in Figure 3.2.6 on page 57 :

1. Verification SCU opens an association with the Verification SCP;

2. Verification SCU sends a C-Echo Request;
3. Verification SCP sends a C-Echo Response;
4. Verification SCU closes the association.

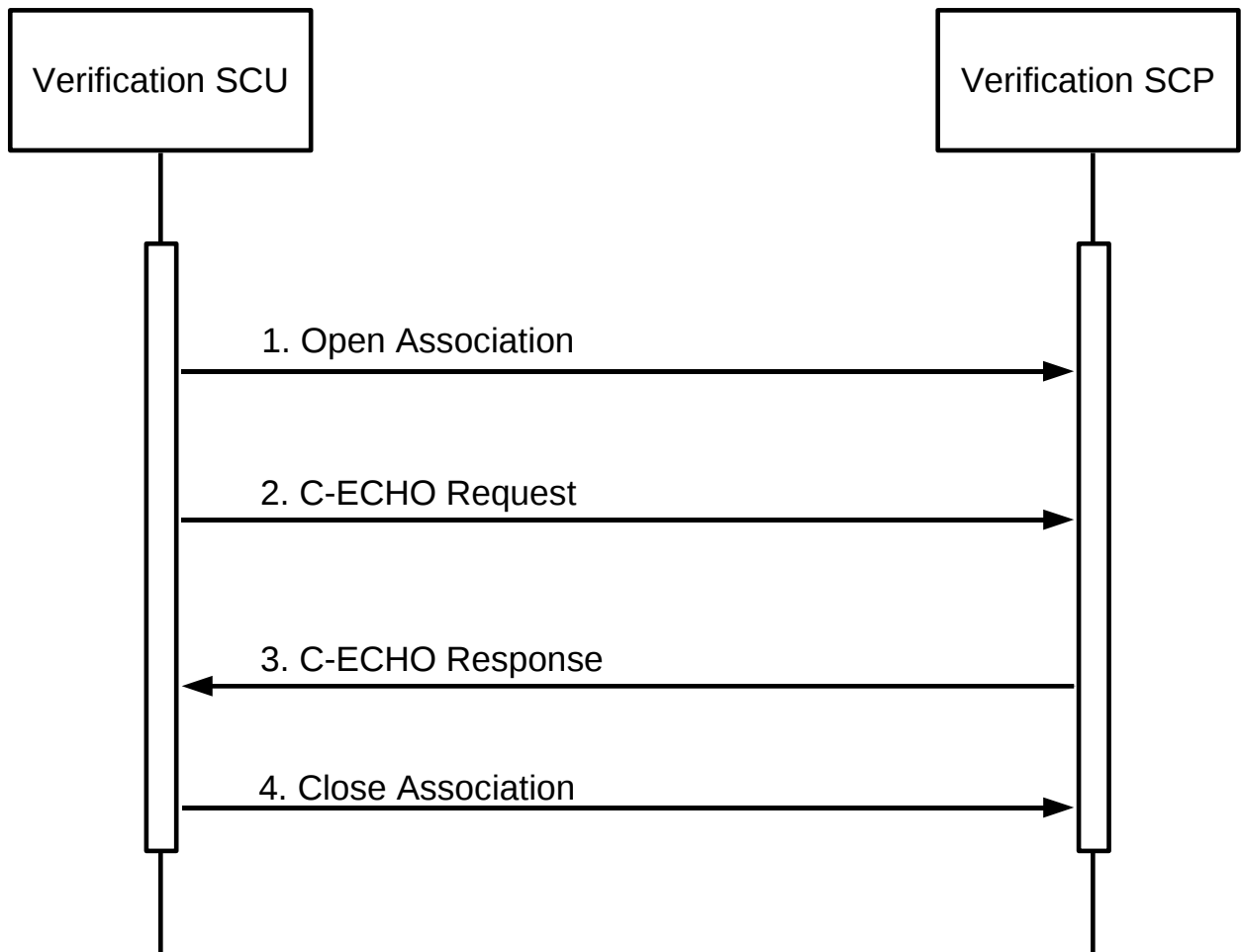

Figure 3.2.6: *Sequencing of Activity - CEcho SCU*

3.2.4.3.1.2 Proposed Presentation Contexts

Aixplorer will propose Presentation contexts as shown in Table 3.48.

Presentation Context Table					
Abstract Syntax		Transfer Syntax		Role	Extended Negotiation
Name	UID	Name	UID		
Verification SOP Class	1.2.840.10008.1.1	Implicit VR Little Endian	1.2.840.10008.1.2	SCU	NONE

Table 3.48: *Presentation Context Table for Verification SCU*

3.2.5 Storage SCP Application Entity Specification

3.2.5.1 SOP Classes

The Aixplorer's Storage SCP AE provides Standard Conformance to the DICOM 3.0 SOP Classes described in Table 3.49 on page 58.

SOP Class Name	SOP Class UID	SCU	SCP
US Image Storage	1.2.840.10008.5.1.4.1.1.6.1	No	Yes
US Multi-Frame Image Storage	1.2.840.10008.5.1.4.1.1.3.1	No	Yes
(Retired) US Image Storage	1.2.840.10008.5.1.4.1.1.6	No	Yes
(Retired) US Multi-Frame Image Storage	1.2.840.10008.5.1.4.1.1.3	No	Yes
Secondary Capture Image Storage	1.2.840.10008.5.1.4.1.1.7	No	Yes
CT Image Storage	1.2.840.10008.5.1.4.1.1.2	No	Yes
Enhanced CT Image Storage	1.2.840.10008.5.1.4.1.1.2.1	No	Yes
MR Image Storage	1.2.840.10008.5.1.4.1.1.4	No	Yes
Enhanced MR Image Storage	1.2.840.10008.5.1.4.1.1.4.1	No	Yes
Digital Mammography X-Ray Image Storage - For Presentation	1.2.840.10008.5.1.4.1.1.1.2	No	Yes
Digital Mammography X-Ray Image Storage - For Processing	1.2.840.10008.5.1.4.1.1.1.2.1	No	Yes
Nuclear Medecine Image Storage	1.2.840.10008.5.1.4.1.1.20	No	Yes
Multiframe Single Bit Secondary Capture Image Storage	1.2.840.10008.5.1.4.1.1.7.1	No	Yes
Multiframe Grayscale Byte Secondary Capture Image Storage	1.2.840.10008.5.1.4.1.1.7.2	No	Yes
Multiframe Grayscale Word Secondary Capture Image Storage	1.2.840.10008.5.1.4.1.1.7.3	No	Yes
Multiframe True Color Secondary Capture Image Storage	1.2.840.10008.5.1.4.1.1.7.4	No	Yes

Table 3.49: *SOP Classes for Storage SCP AE*

3.2.5.2 Association Policies

3.2.5.2.1 General

The Storage SCP AE accepts but never initiates associations.

The maximum PDU size accepted by Storage SCP AE is described in Table 3.50 on page 58.

Maximum pdu size received	16384
---------------------------	-------

Table 3.50: *Maximum PDU size received as a SCP for Storage SCP*

3.2.5.2.2 Number of Associations

As shown in Table 3.51 on page 58, the Storage SCP AE may accept an unlimited number of simultaneous associations.

Maximum number of simultaneous Associations	Unlimited
---	-----------

Table 3.51: *Number of Associations as a SCP for Storage SCP AE*

3.2.5.2.3 Asynchronous Nature

The Storage SCP AE will only allow a single outstanding operation on an Association. Therefore, the Storage SCP AE will not perform asynchronous operations during negotiation.

3.2.5.2.4 Implementation Identifying Information

The implementation information for the Storage SCP Application Entity is described in Table 3.52.

Implementation Class UID	1.2.250.1.204.0.1.20100608.0.3.5.5
Implementation Version Name	SSI_DCMTK_355

Table 3.52: *DICOM Implementation Class and Version for Storage SCP AE*

3.2.5.3 Association Initiation Policy

The Storage SCP AE does not initiate associations.

3.2.5.4 Association Acceptance Policy

When Storage SCP accepts an association, it will respond to storage requests. Connections from any host are accepted.

3.2.5.4.1 Activity – Store instances on local storage

3.2.5.4.1.1 Description and Sequencing of Activities

As instances are received, they are copied to the local file system and a record inserted into the local database. If the received instance is a duplicate of a previously received instance, the old file and database record will be overwritten with the new one. Aixplorer’s storage area is limited, thus oldest instances will be automatically deleted.

A possible sequence of interactions between Storage SCP AE and a Remote Storage SCU AE is illustrated in Figure 3.2.7 on the next page:

1. A Remote Storage SCU AE opens an association with the Aixplorer’s Storage SCP AE,
2. Acquired image(s) is transmitted to the Storage SCP AE using a C-STORE request and the Storage SCP AE replies with a C-STORE response (status success),
3. Remote Storage SCU AE closes the association with the Aixplorer’s Storage SCP AE.

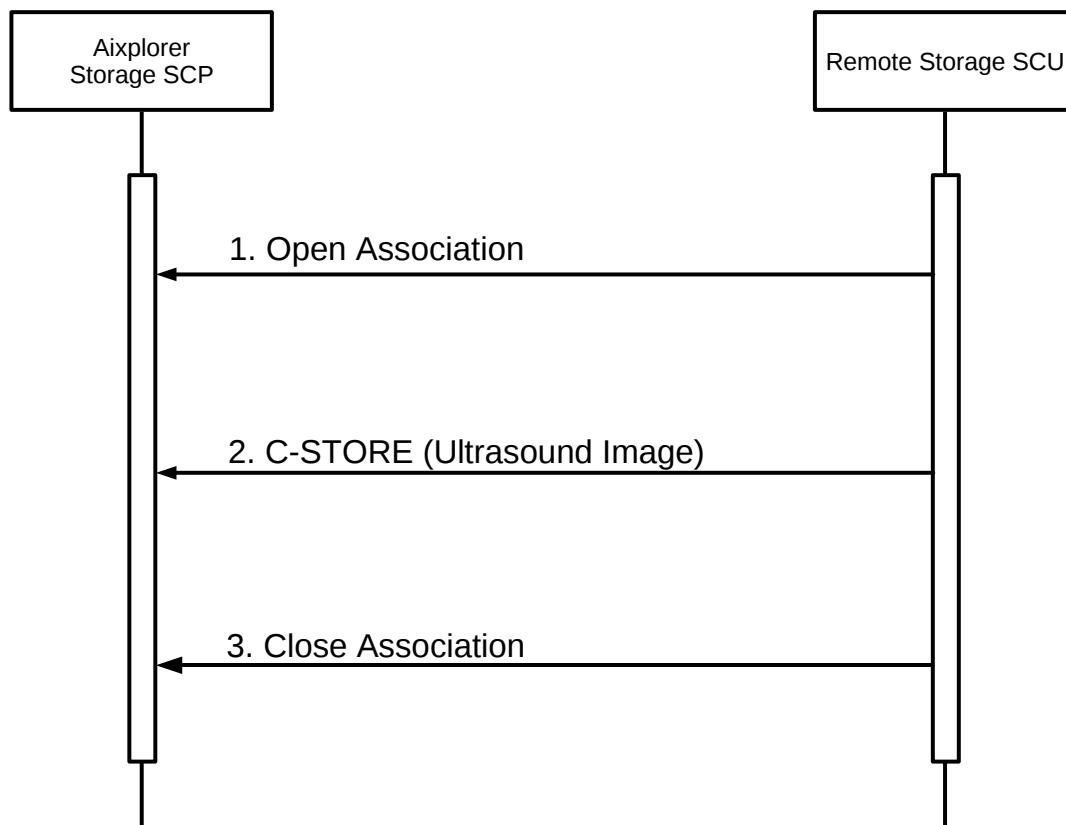

Figure 3.2.7: Sequencing of Activity - Send Images

3.2.5.4.1.2 Accepted Presentation Contexts

Each time an association is initiated, both SCU and SCP proposes a number of Presentation Contexts to be used on that association. The Presentation Contexts accepted by Store SCP AE:

- for a C-Store service are defined in Table 3.53 on page 67.
- for a C-Echo service are defined in Table 3.54 on page 68.

Presentation Context Table					
Abstract Syntax		Transfer Syntax		Role	Extended Negotiation
Name	UID	Name	UID		
Ultrasound Image Storage	1.2.840.10008.5.1.4.1.1.6.1	Implicit VR Little Endian	1.2.840.10008.1.2	SCP	NONE
		Explicit VR Little Endian	1.2.840.10008.1.2.1	SCP	NONE
		Explicit VR Big Endian	1.2.840.10008.1.2.2	SCP	NONE
		JPEG Baseline : Default Transfer Syntax for Lossy JPEG 8 Bit Image Compression	1.2.840.10008.1.2.4.50	SCP	NONE
		JPEG Lossless Compressed	1.2.840.10008.1.2.4.70	SCP	NONE
Ultrasound Multi-Frame Image Storage	1.2.840.10008.5.1.4.1.1.3.1	Implicit VR Little Endian	1.2.840.10008.1.2	SCP	NONE
		Explicit VR Little Endian	1.2.840.10008.1.2.1	SCP	NONE
		Explicit VR Big Endian	1.2.840.10008.1.2.2	SCP	NONE
		JPEG Baseline : Default Transfer Syntax for Lossy JPEG 8 Bit Image Compression	1.2.840.10008.1.2.4.50	SCP	NONE
		JPEG Lossless Compressed	1.2.840.10008.1.2.4.70	SCP	NONE
(Retired) Ultrasound Image Storage	1.2.840.10008.5.1.4.1.1.6	Implicit VR Little Endian	1.2.840.10008.1.2	SCP	NONE
		Explicit VR Little Endian	1.2.840.10008.1.2.1	SCP	NONE
		Explicit VR Big Endian	1.2.840.10008.1.2.2	SCP	NONE
		JPEG Baseline : Default Transfer Syntax for Lossy JPEG 8 Bit Image Compression	1.2.840.10008.1.2.4.50	SCP	NONE
		JPEG Lossless Compressed	1.2.840.10008.1.2.4.70	SCP	NONE
(Retired) Ultrasound Multi-Frame Image Storage	1.2.840.10008.5.1.4.1.1.3	Implicit VR Little Endian	1.2.840.10008.1.2	SCP	NONE
		Explicit VR Little Endian	1.2.840.10008.1.2.1	SCP	NONE
		Explicit VR Big Endian	1.2.840.10008.1.2.2	SCP	NONE
		JPEG Baseline : Default Transfer Syntax for Lossy JPEG 8 Bit Image Compression	1.2.840.10008.1.2.4.50	SCP	NONE
		JPEG Lossless Compressed	1.2.840.10008.1.2.4.70	SCP	NONE
Secondary Capture Image Storage	1.2.840.10008.5.1.4.1.1.7	Implicit VR Little Endian	1.2.840.10008.1.2	SCP	NONE
		Explicit VR Little Endian	1.2.840.10008.1.2.1	SCP	NONE
		Explicit VR Big Endian	1.2.840.10008.1.2.2	SCP	NONE
		JPEG Baseline : Default Transfer Syntax for Lossy JPEG 8 Bit Image Compression	1.2.840.10008.1.2.4.50	SCP	NONE

		JPEG Lossless Compressed	1.2.840.10008.1.2.4.70	SCP	NONE
CT Image Storage	1.2.840.10008.5.1.4.1.1.2	Implicit VR Little Endian	1.2.840.10008.1.2	SCP	NONE
		Explicit VR Little Endian	1.2.840.10008.1.2.1	SCP	NONE
		Explicit VR Big Endian	1.2.840.10008.1.2.2	SCP	NONE
		JPEG Baseline : Default Transfer Syntax for Lossy JPEG 8 Bit Image Compression	1.2.840.10008.1.2.4.50	SCP	NONE
		JPEG Lossless Compressed	1.2.840.10008.1.2.4.70	SCP	NONE
Enhanced CT Image Storage	1.2.840.10008.5.1.4.1.1.2.1	Implicit VR Little Endian	1.2.840.10008.1.2	SCP	NONE
		Explicit VR Little Endian	1.2.840.10008.1.2.1	SCP	NONE
		Explicit VR Big Endian	1.2.840.10008.1.2.2	SCP	NONE
		JPEG Baseline : Default Transfer Syntax for Lossy JPEG 8 Bit Image Compression	1.2.840.10008.1.2.4.50	SCP	NONE
		JPEG Lossless Compressed	1.2.840.10008.1.2.4.70	SCP	NONE
MR Image Storage	1.2.840.10008.5.1.4.1.1.4	Implicit VR Little Endian	1.2.840.10008.1.2	SCP	NONE
		Explicit VR Little Endian	1.2.840.10008.1.2.1	SCP	NONE
		Explicit VR Big Endian	1.2.840.10008.1.2.2	SCP	NONE
		JPEG Baseline : Default Transfer Syntax for Lossy JPEG 8 Bit Image Compression	1.2.840.10008.1.2.4.50	SCP	NONE
		JPEG Lossless Compressed	1.2.840.10008.1.2.4.70	SCP	NONE
Enhanced MR Image Storage	1.2.840.10008.5.1.4.1.1.4.1	Implicit VR Little Endian	1.2.840.10008.1.2	SCP	NONE
		Explicit VR Little Endian	1.2.840.10008.1.2.1	SCP	NONE
		Explicit VR Big Endian	1.2.840.10008.1.2.2	SCP	NONE
		JPEG Baseline : Default Transfer Syntax for Lossy JPEG 8 Bit Image Compression	1.2.840.10008.1.2.4.50	SCP	NONE
		JPEG Lossless Compressed	1.2.840.10008.1.2.4.70	SCP	NONE

Digital Mam- mography X-Ray Image Storage - For Presentation	1.2.840.10008.5.1.4.1.1.1.2	Implicit VR Little Endian	1.2.840.10008.1.2	SCP	NONE
		Explicit VR Little Endian	1.2.840.10008.1.2.1	SCP	NONE
		Explicit VR Big Endian	1.2.840.10008.1.2.2	SCP	NONE
		JPEG Baseline : Default Transfer Syntax for Lossy JPEG 8 Bit Image Compression	1.2.840.10008.1.2.4.50	SCP	NONE
		JPEG Lossless Compressed	1.2.840.10008.1.2.4.70	SCP	NONE
Digital Mam- mography X-Ray Image Storage - For Processing	1.2.840.10008.5.1.4.1.1.1.2.1	Implicit VR Little Endian	1.2.840.10008.1.2	SCP	NONE
		Explicit VR Little Endian	1.2.840.10008.1.2.1	SCP	NONE
		Explicit VR Big Endian	1.2.840.10008.1.2.2	SCP	NONE
		JPEG Baseline : Default Transfer Syntax for Lossy JPEG 8 Bit Image Compression	1.2.840.10008.1.2.4.50	SCP	NONE
		JPEG Lossless Compressed	1.2.840.10008.1.2.4.70	SCP	NONE
Nuclear Medecine Image Storage	1.2.840.10008.5.1.4.1.1.1.20	Implicit VR Little Endian	1.2.840.10008.1.2	SCP	NONE
		Explicit VR Little Endian	1.2.840.10008.1.2.1	SCP	NONE
		Explicit VR Big Endian	1.2.840.10008.1.2.2	SCP	NONE
		JPEG Baseline : Default Transfer Syntax for Lossy JPEG 8 Bit Image Compression	1.2.840.10008.1.2.4.50	SCP	NONE
		JPEG Lossless Compressed	1.2.840.10008.1.2.4.70	SCP	NONE
Multiframe Single Bit Secondary Capture Image Storage	1.2.840.10008.5.1.4.1.1.1.7.1	Implicit VR Little Endian	1.2.840.10008.1.2	SCP	NONE
		Explicit VR Little Endian	1.2.840.10008.1.2.1	SCP	NONE
		Explicit VR Big Endian	1.2.840.10008.1.2.2	SCP	NONE
		JPEG Baseline : Default Transfer Syntax for Lossy JPEG 8 Bit Image Compression	1.2.840.10008.1.2.4.50	SCP	NONE
		JPEG Lossless Compressed	1.2.840.10008.1.2.4.70	SCP	NONE

Multiframe Grayscale Byte Secondary Capture Image Storage	1.2.840.10008.5.1.4.1.1.7.2	Implicit VR Little Endian	1.2.840.10008.1.2	SCP	NONE
		Explicit VR Little Endian	1.2.840.10008.1.2.1	SCP	NONE
		Explicit VR Big Endian	1.2.840.10008.1.2.2	SCP	NONE
		JPEG Baseline : Default Transfer Syntax for Lossy JPEG 8 Bit Image Compression	1.2.840.10008.1.2.4.50	SCP	NONE
		JPEG Lossless Compressed	1.2.840.10008.1.2.4.70	SCP	NONE
Multiframe Grayscale Word Secondary Capture Image Storage	1.2.840.10008.5.1.4.1.1.7.3	Implicit VR Little Endian	1.2.840.10008.1.2	SCP	NONE
		Explicit VR Little Endian	1.2.840.10008.1.2.1	SCP	NONE
		Explicit VR Big Endian	1.2.840.10008.1.2.2	SCP	NONE
		JPEG Baseline : Default Transfer Syntax for Lossy JPEG 8 Bit Image Compression	1.2.840.10008.1.2.4.50	SCP	NONE
		JPEG Lossless Compressed	1.2.840.10008.1.2.4.70	SCP	NONE
Multiframe True Color Secondary Capture Image Storage	1.2.840.10008.5.1.4.1.1.7.4	Implicit VR Little Endian	1.2.840.10008.1.2	SCP	NONE
		Explicit VR Little Endian	1.2.840.10008.1.2.1	SCP	NONE
		Explicit VR Big Endian	1.2.840.10008.1.2.2	SCP	NONE
		JPEG Baseline : Default Transfer Syntax for Lossy JPEG 8 Bit Image Compression	1.2.840.10008.1.2.4.50	SCP	NONE
		JPEG Lossless Compressed	1.2.840.10008.1.2.4.70	SCP	NONE
Computed Radiography Image Storage	1.2.840.10008.5.1.4.1.1.1	Implicit VR Little Endian	1.2.840.10008.1.2	SCP	NONE
		Explicit VR Little Endian	1.2.840.10008.1.2.1	SCP	NONE
		Explicit VR Big Endian	1.2.840.10008.1.2.2	SCP	NONE
		JPEG Baseline : Default Transfer Syntax for Lossy JPEG 8 Bit Image Compression	1.2.840.10008.1.2.4.50	SCP	NONE
		JPEG Lossless Compressed	1.2.840.10008.1.2.4.70	SCP	NONE
Digital XRay Image Storage - For Presentation	1.2.840.10008.5.1.4.1.1.1.1	Implicit VR Little Endian	1.2.840.10008.1.2	SCP	NONE
		Explicit VR Little Endian	1.2.840.10008.1.2.1	SCP	NONE
		Explicit VR Big Endian	1.2.840.10008.1.2.2	SCP	NONE
		JPEG Baseline : Default Transfer Syntax for Lossy JPEG 8 Bit Image Compression	1.2.840.10008.1.2.4.50	SCP	NONE
		JPEG Lossless Compressed	1.2.840.10008.1.2.4.70	SCP	NONE

Digital XRay Image Storage - For Processing	1.2.840.10008.5.1.4.1.1.1.1	Implicit VR Little Endian	1.2.840.10008.1.2	SCP	NONE
		Explicit VR Little Endian	1.2.840.10008.1.2.1	SCP	NONE
		Explicit VR Big Endian	1.2.840.10008.1.2.2	SCP	NONE
		JPEG Baseline : Default Transfer Syntax for Lossy JPEG 8 Bit Image Compression	1.2.840.10008.1.2.4.50	SCP	NONE
		JPEG Lossless Compressed	1.2.840.10008.1.2.4.70	SCP	NONE
RETIRED Nuclear Medicine Image Storage	1.2.840.10008.5.1.4.1.1.5	Implicit VR Little Endian	1.2.840.10008.1.2	SCP	NONE
		Explicit VR Little Endian	1.2.840.10008.1.2.1	SCP	NONE
		Explicit VR Big Endian	1.2.840.10008.1.2.2	SCP	NONE
		JPEG Baseline : Default Transfer Syntax for Lossy JPEG 8 Bit Image Compression	1.2.840.10008.1.2.4.50	SCP	NONE
		JPEG Lossless Compressed	1.2.840.10008.1.2.4.70	SCP	NONE
XRay Angiographic Image Storage	1.2.840.10008.5.1.4.1.1.12.1	Implicit VR Little Endian	1.2.840.10008.1.2	SCP	NONE
		Explicit VR Little Endian	1.2.840.10008.1.2.1	SCP	NONE
		Explicit VR Big Endian	1.2.840.10008.1.2.2	SCP	NONE
		JPEG Baseline : Default Transfer Syntax for Lossy JPEG 8 Bit Image Compression	1.2.840.10008.1.2.4.50	SCP	NONE
		JPEG Lossless Compressed	1.2.840.10008.1.2.4.70	SCP	NONE
Enhanced XA Image Storage	1.2.840.10008.5.1.4.1.1.12.1	Implicit VR Little Endian	1.2.840.10008.1.2	SCP	NONE
		Explicit VR Little Endian	1.2.840.10008.1.2.1	SCP	NONE
		Explicit VR Big Endian	1.2.840.10008.1.2.2	SCP	NONE
		JPEG Baseline : Default Transfer Syntax for Lossy JPEG 8 Bit Image Compression	1.2.840.10008.1.2.4.50	SCP	NONE
		JPEG Lossless Compressed	1.2.840.10008.1.2.4.70	SCP	NONE

XRay Radiofluoro- scopic Image Storage	1.2.840.10008.5.1.4.1.1.12.2	Implicit VR Little Endian	1.2.840.10008.1.2	SCP	NONE
		Explicit VR Little Endian	1.2.840.10008.1.2.1	SCP	NONE
		Explicit VR Big Endian	1.2.840.10008.1.2.2	SCP	NONE
		JPEG Baseline : Default Transfer Syntax for Lossy JPEG 8 Bit Image Compression	1.2.840.10008.1.2.4.50	SCP	NONE
		JPEG Lossless Compressed	1.2.840.10008.1.2.4.70	SCP	NONE
Enhanced XRF Image Storage	1.2.840.10008.5.1.4.1.1.12.2.1	Implicit VR Little Endian	1.2.840.10008.1.2	SCP	NONE
		Explicit VR Little Endian	1.2.840.10008.1.2.1	SCP	NONE
		Explicit VR Big Endian	1.2.840.10008.1.2.2	SCP	NONE
		JPEG Baseline : Default Transfer Syntax for Lossy JPEG 8 Bit Image Compression	1.2.840.10008.1.2.4.50	SCP	NONE
		JPEG Lossless Compressed	1.2.840.10008.1.2.4.70	SCP	NONE
VL Endoscopic Image Storage	1.2.840.10008.5.1.4.1.1.77.1.1	Implicit VR Little Endian	1.2.840.10008.1.2	SCP	NONE
		Explicit VR Little Endian	1.2.840.10008.1.2.1	SCP	NONE
		Explicit VR Big Endian	1.2.840.10008.1.2.2	SCP	NONE
		JPEG Baseline : Default Transfer Syntax for Lossy JPEG 8 Bit Image Compression	1.2.840.10008.1.2.4.50	SCP	NONE
		JPEG Lossless Compressed	1.2.840.10008.1.2.4.70	SCP	NONE
VL Microscopic Image Storage	1.2.840.10008.5.1.4.1.1.77.1.2	Implicit VR Little Endian	1.2.840.10008.1.2	SCP	NONE
		Explicit VR Little Endian	1.2.840.10008.1.2.1	SCP	NONE
		Explicit VR Big Endian	1.2.840.10008.1.2.2	SCP	NONE
		JPEG Baseline : Default Transfer Syntax for Lossy JPEG 8 Bit Image Compression	1.2.840.10008.1.2.4.50	SCP	NONE
		JPEG Lossless Compressed	1.2.840.10008.1.2.4.70	SCP	NONE
Positron Emission Tomography Image Storage	1.2.840.10008.5.1.4.1.1.128	Implicit VR Little Endian	1.2.840.10008.1.2	SCP	NONE
		Explicit VR Little Endian	1.2.840.10008.1.2.1	SCP	NONE
		Explicit VR Big Endian	1.2.840.10008.1.2.2	SCP	NONE
		JPEG Baseline : Default Transfer Syntax for Lossy JPEG 8 Bit Image Compression	1.2.840.10008.1.2.4.50	SCP	NONE
		JPEG Lossless Compressed	1.2.840.10008.1.2.4.70	SCP	NONE

Table 3.53: Acceptable Presentation Contexts for Storage SCP and receive storage request

Presentation Context Table					
Abstract Syntax		Transfer Syntax		Role	Extended Negotiation
Name	UID	Name	UID		
Verification	1.2.840.10008.1.1	Implicit VR Little Endian	1.2.840.10008.1.2	SCP	NONE
		Explicit VR Little Endian	1.2.840.10008.1.2.1	SCP	NONE
		Explicit VR Big Endian	1.2.840.10008.1.2.2	SCP	NONE

Table 3.54: *Acceptable Presentation Contexts for Storage SCP and receive Echo request*

3.2.5.4.1.2.1. Extended Negotiation

No extended negotiation is performed, though Storage SCP:

- is a Level 2 Storage SCP (Full – does not discard any data elements);
- does not support digital signatures;
- does not coerce any received data elements.

3.2.5.4.1.3 SOP Specific Conformance

3.2.5.4.1.3.1. SOP Specific Conformance to Storage SCP SOP Classes

Storage SCP provides standard conformance to the Storage Service Class.

3.2.5.4.1.3.2. SOP Specific Conformance to Storage SCP SOP Classes

Storage SCP will always accept any Presentation Context for the supported SOP Classes with the supported Transfer Syntaxes. More than one proposed Presentation Context will be accepted for the same Abstract Syntax if the Transfer Syntax is supported, whether or not it is the same as another Presentation Context.

3.2.5.4.1.3.3. Transfer Syntax Selection Policies

The default behavior of the Storage SCP is to prefer transfer syntaxes having an explicit encoding over the default implicit transfer syntax and since Storage SCP is running on little-endian hardware it will prefer Little Endian Explicit to Big Endian Explicit transfer syntax.

3.2.5.4.1.3.4. Response Status

Storage SCP will behave as described in Table 3.55 when generating the C-STORE response command message.

Service Status	Further Meaning	Error Code	Reasons
Refused	Out of Resources	A7xx	Never sent
Error	Data Set does not match SOP Class	A9xx	Never sent – data set is not checked prior to storage
	Cannot understand	Cxxx	Never sent
Warning	Coercion of Data Elements	B000	Never sent - no coercion is ever performed
	Data Set does not match SOP Class	B007	Never sent - data set is not checked prior to storage
	Elements Discarded	B006	Never sent – all elements are always stored
Success	Success	0000	

Table 3.55: *Response Status for Storage SCP and Receive Storage Request*

3.2.6 Query/Retrieve Application Entity Specification

3.2.6.1 SOP Classes

The Query/Retrieve AE provides Standard Conformance to the DICOM 3.0 SOP Classes described in Table 3.56.

SOP Class Name	SOP Class UID	SCU	SCP
Study Root Query/Retrieve Information Model – FIND	1.2.840.10008.5.1.4.1.2.2.1	Yes	No
Study Root Query/Retrieve Information Model – MOVE	1.2.840.10008.5.1.4.1.2.2.2	Yes	No

Table 3.56: *SOP Classes for AE Query/Retrieve*

3.2.6.2 Association Policies

3.2.6.2.1 General

As illustrated in Table 3.57 on the following page, the DICOM 3.0 standard Application context is always specified for each association.

Application Context Name	1.2.840.10008.3.1.1.1
--------------------------	-----------------------

Table 3.57: DICOM Application Context for Query/Retrieve AE

3.2.6.2.2 Number of Associations

The Query/Retrieve AE may initiates Two Association at a time (see Table 3.58) :

- One C-Find request;
- One C-Move request.

Maximum number of simultaneous Associations	1 Find 1 Move
---	------------------

Table 3.58: Number of Associations as an Association Initiator for Query/Retrieve AE

3.2.6.2.3 Asynchronous Nature As illustrated in Table 3.59, the Query/Retrieve AE does not support asynchronous communication (multiple outstanding transactions over a single Association).

Maximum number of outstanding asynchronous transactions	0
---	---

Table 3.59: Asynchronous Nature as an Association Initiator for Query/Retrieve AE

3.2.6.2.4 Implementation Identifying Information The implementation information for the Query/Retrieve Application Entity is described in Table 3.60 on the next page.

3.2.6.3 Association Initiation Policy

3.2.6.3.1 Activity - Query Request

3.2.6.3.1.1 Description and Sequencing of Activity

The Find SCU attempts to initiate a new association when the user performs the query action from the user interface. If this involves recursive queries for lower query levels in the hierarchy, these will be performed on other associations. A single attempt will be made to query the remote AE. If the query fails, for whatever reason, no retry will be performed.

Implementation Class UID	1.2.250.1.204.0.1.20100608.0.3.5.5
Implementation Version Name	SSI_DCMTK_355

Table 3.60: DICOM Implementation Class and Version for Query/Retrieve AE

3.2.6.3.1.2 Proposed presentation Context

Each time an association is initiated, the Association Initiator proposes a number of Presentation Contexts to be used on that association. The Presentation Contexts proposed by Aixplorer for a C-Find service are defined in Table 3.2.6.3.1.2.

Presentation Context Table					
Abstract Syntax		Transfer Syntax		Role	Extended Negotiation
Name	UID	Name	UID		
FIND Study Root	1.2.840.10008.5.1.4.1.2.2.1	Implicit VR Little Endian	1.2.840.10008.1.2	SCU	NONE
Query/Retrieve		Explicit VR Little Endian	1.2.840.10008.1.2.1	SCU	NONE
Information Model		Explicit VR Big Endian	1.2.840.10008.1.2.2	SCU	NONE

Table 3.61: Proposed Presentation Contexts for Activity Query Request

3.2.6.3.1.2.1. Extended Negotiation

No extended negotiation is performed.
In particular, relational queries are not supported.

3.2.6.3.1.3 SOP Specific Conformance

3.2.6.3.1.3.1. SOP Specific Conformance to C-FIND SOP Classes

FIND-SCU provides standard conformance to the supported C-FIND SOP Classes. Only a single information model, Study Root, is supported. All queries are initiated at the highest level of the information model (the STUDY level), and then for each response received, recursively repeated at the next lower level (the SERIES level), in order to elucidate the “tree” of series available on the remote AE (from which the user may subsequently request a retrieval at Series level).

A CANCEL request will be sent if the number of series receive is greater than a configurable limit.

Table 3.62 on page 73 show the requested identifier at the Study and Series Information level of the Study Root Query/Retrieve Information Model. The types of Matching supported by the

Find SCU is the following :

- “S” indicates the identifier attribute uses Single Value Matching,
- “R” indicates Range Matching,
- “*” indicates wildcard matching,
- “U” indicates Universal Matching,
- “L” indicates that UID lists are sent,
- “NONE” indicates that no matching is supported, but that values for this Element are requested to be returned (*i.e.* universal matching),
- “UNIQUE” indicates that this is the Unique Key for that query level, in which case Universal Matching or Single Value Matching is used depending on the query level.

3.2.6.3.1.3.2. Presentation Context Acceptance Criterion

The Find SCU does not accept associations.

3.2.6.3.1.3.3. Transfer Syntax Selection Policies

The Find SCU prefers explicit Transfer Syntaxes. If offered a choice of Transfer Syntaxes in the accepted Presentation Contexts, it will choose the Little-Endian Explicit Transfer Syntax.

3.2.6.3.1.3.4. Response Status

The Find SCU will behave as described in Table 3.63 on page 74 in response to the status returned in the C-FIND response command message(s).

3.2.6.3.2 Activity - Retrieve Exam

3.2.6.3.2.1 Description and Sequencing of Activity

For series selected from the user interface to be retrieved, a single attempt will be made to retrieve them from the selected remote AE. If the retrieve fails, for whatever reason, no retry will be performed.

3.2.6.3.2.2 Proposed presentation Context

Each time an association is initiated, the Association Initiator proposes a number of Presentation Contexts to be used on that association. The Presentation Contexts proposed by Aixplorer for a C-Move service are defined in Table 3.64 on page 75.

Description	Tag	Type
Study Level		
Study Date	(0008,0020)	S, *, U, R
Study Time	(0008,0030)	U
Accession Number	(0008,0050)	S, *, U
Patient's Name	(0010,0010)	S, *, U
Patient ID	(0010,0020)	S, *, U
Study ID	(0020,0010)	U
Study Instance UID	(0020,000D)	UNIQUE
Modalities in Study	(0008,0061)	U
SOP Classes in Study	(0008,0062)	U
Referring Physician's Name	(0008,0090)	U
Study Description	(0008,1030)	U
Name of Physician(s) Reading Study	(0008,1060)	U
Patient's Birth Date	(0010,0030)	U
Patient's Birth Time	(0010,0032)	U
Patient's Sex	(0010,0040)	U
Number of Study Related Series	(0020,1206)	NONE
Retrieve AE Title	(0008,0054)	U
Series Level		
Series Number	(0020,0011)	U
Modality	(0008,0060)	S,U
Series Instance UID	(0020,000E)	UNIQUE
Number of Study Related Instances	(0020,1208)	NONE

Table 3.62: Study Root request identifier for Find SCU

Service Status	Further Meaning	Error Code	Behavior
Refused	Out of Resources	A700	Current query is terminated, remaining queries continue.
Error	Identifier does not match SOP Class	A900	Current query is terminated, remaining queries continue
	Unable to process	Cxxx	Current query is terminated, remaining queries continue
Cancel	Matching terminated due to Cancel request	FE00	A CANCEL request will be sent if the number of series receive is greated than a configurable limit
Success	Matching is complete - No final Identifier is supplied	0000	Current query is terminated, remaining queries continue
Pending	Matches are continuing - Current Match is supplied and any Optional Keys were supported in the same manner as Required Keys	FF00	Identifier used to populate browser and trigger recursive lower level queries
	Matches are continuing - Warning that one or more Optional Keys were not supported for existence and/or matching for this Identifier	FF01	Identifier used to populate browser and trigger recursive lower level queries

Table 3.63: *Response Status for Find SCU and Query Remote AE Request*

Presentation Context Table					
Abstract Syntax		Transfer Syntax		Role	Extended Negotiation
Name	UID	Name	UID		
MOVE Study Root	1.2.840.10008.5.1.4.1.2.2.2	Implicit VR Little Endian	1.2.840.10008.1.2	SCU	NONE
Query Retrieve		Explicit VR Little Endian	1.2.840.10008.1.2.1	SCU	NONE
Information Model		Explicit VR Big Endian	1.2.840.10008.1.2.2	SCU	NONE

Table 3.64: Proposed Presentation Contexts for Activity Retrieve Exam Request

3.2.6.3.2.2.1. Extended Negotiation

No extended negotiation is performed.
In particular, relational retrievals are not supported.

3.2.6.3.2.3 SOP Specific Conformance

3.2.6.3.2.3.1. SOP Specific Conformance to C-FIND SOP Classes

The Move SCU provides standard conformance to the supported C-MOVE SOP Classes. Only a single information model, Study Root, is supported. A retrieval will be performed at the SERIES level.

No CANCEL requests are ever issued.

The retrieval is performed from the AE that was specified in the Retrieve AE attribute returned from the query performed by FIND-SCU. The instances are retrieved to the current application's local database by specifying the destination as the AE Title of the STORE-SCP AE of the local application.

3.2.6.3.2.3.2. Presentation Context Acceptance Criterion

The Move SCU does not accept associations.

3.2.6.3.2.3.3. Transfer Syntax Selection Policies

The Move SCU prefers explicit Transfer Syntaxes. If offered a choice of Transfer Syntaxes in the accepted Presentation Contexts, it will choose the Little-Endian Explicit Transfer Syntax.

3.2.6.3.2.3.4. Response Status

The Move SCU will behave as described in Table 3.65 on the facing page in response to the status returned in the C-MOVE response command message(s).

3.2.6.3.2.3.5. Sub-operation dependent behavior

Since the C-MOVE operation is dependent on completion of C-STORE sub-operations that are occurring on a separate association, the question of failure of operations on the other association(s) must be considered.

The Move SCU completely ignores whatever activities are taking place in relation to the Storage SCP AE that is receiving the retrieved instances. Once the C-MOVE has been initiated it runs to completion (or failure) as described in the C-MOVE response command message(s). There is no attempt by Move SCU to confirm that instances have actually been successfully received or locally stored. Whether or not completely or partially successful retrievals are made available in the local database to the user is purely dependent on the success or failure of the C-STORE sub-operations, not on any explicit action by Move SCU.

Whether or not the remote AE attempts to retry any failed C-STORE sub-operations is beyond the control of Move SCU.

If the association on which the C-MOVE was issued is aborted for any reason, whether or not the C-STORE sub-operations continue is dependent on the remote AE; the local Storage SCP will continue to accept associations and storage operations regardless.

3.2.6.4 Association Acceptance Policy

The Query/Retrieve AE does not accept Associations.

3.3 Network Interfaces

3.3.1 Physical Network Interface

Aixplorer supports a single network interface. The following physical network interfaces are supported:

- Ethernet 10baseT;
- Ethernet 100baseT;
- Ethernet 1000baseT.

Service Status	Further Meaning	Status Code	Related Fields	Behavior
Refused	Out of Resources - Unable to calculate number of matches	A701	(0000,0902)	Retrieval is terminated
	Out of Resources - Unable to perform sub-operations	A702	(0000,1020) (0000,1021) (0000,1022) (0000,1023)	Retrieval is terminated
	Move Destination unknown	A801	(0000,0902)	Retrieval is terminated
Failed	Identifier does not match SOP Class	A900	(0000,0901) (0000,0902) (0000,0901)	Retrieval is terminated
	Unable to process	Cxxx	(0000,0902)	Retrieval is terminated
Cancel	Sub-operations terminated due to Cancel Indication	FE00	(0000,1020) (0000,1021) (0000,1022) (0000,1023)	Retrieval is terminated (should never occur, since cancels never issued)
Warning	Sub-operations Complete - One or more Failures	B000	(0000,1020) (0000,1022) (0000,1023)	Retrieval is terminated
Success	Sub-operations Complete - No Failures	0000	(0000,1020) (0000,1021) (0000,1022) (0000,1023)	Retrieval is terminated
Pending	Sub-operations are continuing	FF00	(0000,1020) (0000,1021) (0000,1022) (0000,1023)	Retrieval continues

Table 3.65: *Response Status for Move SCU and retrieve from Remote AE Request*

3.3.2 Additional Protocols

Aixplorer conforms to the System Management Profiles listed in the Table below. All requested transactions for the listed profiles and actors are supported. Support for optional transactions is listed in the Table 3.66:

Profile Name	Actor	Protocols Used	Optional Transaction
Network Address Management	DHCP Client	DHCP	N/A
	DNS Client	DNS	N/A
Time Synchronization	NTP Client	NTP	N/A

Table 3.66: *Supported System Management profiles*

3.3.2.1 DHCP

DHCP can be used to obtain TCP/IP network configuration information. The network parameters obtainable via DHCP are shown in Table 3.67. The Default Value column of the table shows the default used if the DHCP server does not provide a value. Support for DHCP can be configured via the “Network Configuration” Window. If DHCP is not in use, TCP/IP network configuration information can be manually configured via the “Network Configuration” Window. If the DHCP server refuses to renew a lease on the assigned IP address all active DICOM

DHCP Parameter	Default Value
IP Address	None
Subnet mask	Derived from IP Address
Time offset	Site configurable
MTU	Network Hardware Dependent

Table 3.67: *Supported DHCP Parameters*

Associations will be aborted.

3.3.2.2 DNS

DNS can be used for address resolution. If DHCP is not in use or the DHCP server does not return any DNS server addresses, the identity of a DNS server can be configured via the “Network Configuration” window.

3.3.2.3 NTP

One NTP Servers can be configured via the “Regional” window. If no NTP Servers are identified then the local clock will be used as a time reference.

3.3.2.4 LDAP

LDAP is not supported.

3.3.3 IPv4 and IPv6 Support

This product only supports IPv4 connections.

3.4 Configuration

3.4.1 AE Title/Presentation Address Mapping

All local applications use the AE Titles and TCP/IP Ports configured via the “System Configuration” → “Administration” → “Devices” tab of Aixplorer. The Field Service Engineer can configure Aixplorer’s own DICOM parameter via the “System DICOM Options” Window. The AE Title must be configured during installation. This AE Title is shared between all local applications.

Please refer to the user’s guide for configuration and use of DICOM Storage.

3.4.2 Parameters

Aixplorer configurable parameters are accessible through the “System Configuration” → “Devices Settings” → “System DICOM Options“ tab of Aixplorer. The three following boxes allow user to configure each Application Entity :

- “Main DICOM options” : this box allow user to configure the basic DICOM services for an acquisition modality (Store SCU, Print SCU, Modality Worklist SCU, Store Commit SCU). The different settings are :
 - AE Title: default is AIXPLORER
 - Debug and Verbose mode: default is disabled
 - Verification port and Store Commit port: default is 8013 (value must be > 1024)
 - Station location : default is echo1
 - Number of tries before error logging default is 3
 - Retry delay between 2 tries : default is 1000 ms

- Connection Timeout : default is 10 ms
- “Store SCP options” : this box allow user to configure the STORE SCP’s parameters:
 - AE Title: default is AIXPLORER_QR
 - listening port : default is 8014
 - deletion method : this option define retrieved instances’ deletion policy.
- “Q/R SCU options” : this box allow user to configure the Query/Retrieve parameters:
 - AE Title: default is AIXPLORER_QR
 - Max responses : limit the number of responses received during a request
 - Automatic Query : if activated, sends automatically a query for the current patient at exam creation
 - Automatic Retrieve : if activated, sends automatically a retrieve request for the current patient at exam creation

The Aixplorer User must set the AE Title, port-number, host-name for an unlimited number of remote Storage SCP, remote Storage Commitment SCP, and Print SCP enabling one or more of them.

The Aixplorer User must set the AE Title, port-number, host-name for an unlimited number of remote MWL SCPs and MPPS SCPs, and Query/Retrieve SCPs enabling only one of them at a given time.

Please refer to the user’s guide for configuration and use of DICOM Storage.

Chapter 4

Media Interchange

4.1 Implementation Model

4.1.1 Application Data flow

The Offline-Media Application Entity exports images and PDF reports to a CD-R, DVD, USB Storage medium. It is associated with the local real-world activities “Export to CD-R, DVD”, “Export to USB”. These real-world activities are performed upon user request for selected patients, studies or instances (images or PDF reports). The application data flow diagram for media storage is illustrated on figure 4.1.1 on the next page.

4.1.2 Functional Definitions of Application Entities

4.1.2.1 Functional Definition of Media Creation Application Entity

Activation of the “Export to CD-R, DVD”, “Export to USB” buttons will pass the currently selected patients, studies or instances to the media creation service. The SOP Instances associated with the selection will be collected into one job. The contents of each export job will be written to a single CD-R or DVD media.

4.1.3 Sequencing of Real-Word Activities

At least one image must exist and be selected before the media creation service can be invoked. The operator can insert a new media at any time before or after invocation of the service. It will wait indefinitely for a media to be inserted before starting to write to the media device. If no media is available the media creation job can be canceled from the job queue.

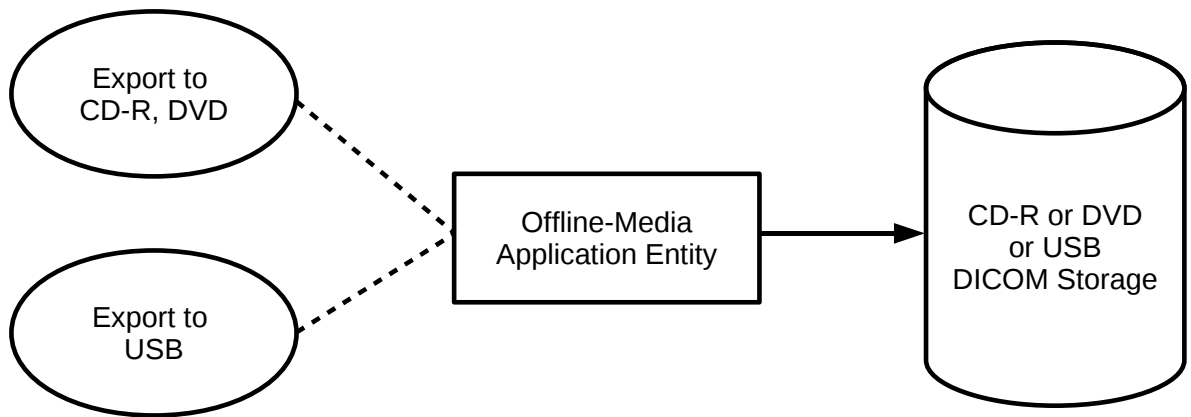

Figure 4.1.1: *Application Data Flow for Media Storage*

4.1.4 File Meta Information for Implementation Class and Version

The implementation information written to the File Meta Header in each file is described in Table 4.1.

Implementation Class UID	1.2.250.1.59.453.280
Implementation version name	ACC_ETIAM_280

Table 4.1: DICOM Implementation Class and Version for DICOMDIR creation

4.2 Application Entity Specifications

4.2.1 Offline-Media Application Entity Specification

The Application Entity provides standard conformance to the Media Storage Service Class. The Application Profiles and roles are listed in Table 4.2 on the next page.

4.2.1.1 File Meta Information for the Application Entity

The Source Application Entity Title included in the File Meta Header is the same AE Title than the one configured for Basic DICOM Option.

4.2.1.2 Real-World Activities

4.2.1.2.1 Activity – Export to CD-R DVD

The Offline-Media Application Entity acts as an FSC when requested to export SOP Instances from the local database to a CD-R or DVD medium. The medium characteristics are automatically detected by the system and shown to user. After user selection of patients, studies and images from the review list window, an exportation job is created by pressing the “CD-R /DVD” button. The contents of the export job will be written together with a corresponding DICOMDIR to a single-session CDR/DVD. Writing in multi-session mode is not supported. The user can cancel an export job in the job queue.

Please refer to the user’s guide for configuration and use of DICOM Storage.

4.2.1.2.1.1 Media Storage Application Profiles

The Offline-Media Application Entity support the Application Profile described in Table 4.3 on the following page.

Application Profile supported	Real World Activity	Role
Compact Disk - Recordable		
General Purpose CD-R Profiles (STD-GEN-CD)	Export to CD-R	FSC
Ultrasound application profile - Single Frame Image Display (STD-US-ID-SF-CDR)	Export to CD-R	FSC
Ultrasound application profile - Single& Multi-Frame Image Display (STD-US-ID-MF-CDR)	Export to CD-R	FSC
120 mm DVD		
General Purpose DVD Interchange with JPEG (STD-GEN-DVD-JPEG)	Export to DVD	FSC
Ultrasound application profile - Single Frame Image Display (STD-US-ID-SF-DVD)	Export to DVD	FSC
Ultrasound application profile - Single& Multi-Frame (STD-US-ID-MF-DVD)	Export to DVD	FSC
DVD Interchange with MPEG2 MP@ML (STD-DVD-MPEG2-MPML)	Export to DVD	FSC
USB connected removable devices¹		
General Purpose USB Media Interchange with JPEG (STD-GEN-USB-JPEG))	Export to USB	FSC

¹The DICOMDIR file is not in the root directory of the medium

Table 4.2: *Application Profiles, activities, and roles for Offline Media*

Application Profile supported
STD-GEN-CD
STD-US-ID-SF-CDR
STD-US-ID-MF-CDR
STD-GEN-DVD-JPEG
STD-US-ID-SF-DVD
STD-US-ID-MF-DVD
STD-DVD-MPEG2-MPML

Table 4.3: *Media Storage Application Profiles for CDR/DVD*

4.2.1.2.1.1.1. Options

The Offline-Media Application Entity supports the SOP Classes and Transfer Syntaxes listed in the Table 4.5 on page 87. Please note that when a Storage Application Profile is selected, the most adapted Transfer Syntaxes is selected for each IOD. At any time Transfer syntaxes can be forced to any value listed in Table 4.5 on page 87. In such case, the created DICOM instances may not follow the Application profile. As a result, the DICOM instances will be present on the DICOM media, but won't be referenced in the DICOMDIR.

Information Object Definition	SOP Class UID	Transfer Syntax UID	Transfer Syntax
Ultrasound Image Storage	1.2.840.10008.5.1.4.1.1.6.1	Implicit VR Little Endian	1.2.840.10008.1.2
		Explicit VR Little Endian	1.2.840.10008.1.2.1
		Explicit VR Big Endian	1.2.840.10008.1.2.2
		JPEG Baseline : Default Transfer Syntax for Lossy JPEG 8 Bit Image Compression	1.2.840.10008.1.2.4.50
		JPEG Lossless Compressed	1.2.840.10008.1.2.4.70
Ultrasound Multi-Frame Image Storage	1.2.840.10008.5.1.4.1.1.3.1	Implicit VR Little Endian	1.2.840.10008.1.2
		Explicit VR Little Endian	1.2.840.10008.1.2.1
		Explicit VR Big Endian	1.2.840.10008.1.2.2
		JPEG Baseline : Default Transfer Syntax for Lossy JPEG 8 Bit Image Compression	1.2.840.10008.1.2.4.50
		JPEG Lossless Compressed	1.2.840.10008.1.2.4.70
		MPEG2 Main Profile @ Main Level	1.2.840.10008.1.2.4.100
(Retired) Ultrasound Image Storage	1.2.840.10008.5.1.4.1.1.6	Implicit VR Little Endian	1.2.840.10008.1.2
		Explicit VR Little Endian	1.2.840.10008.1.2.1
		Explicit VR Big Endian	1.2.840.10008.1.2.2
		JPEG Baseline : Default Transfer Syntax for Lossy JPEG 8 Bit Image Compression	1.2.840.10008.1.2.4.50
		JPEG Lossless Compressed	1.2.840.10008.1.2.4.70
(Retired) Ultrasound Multi-Frame Image Storage	1.2.840.10008.5.1.4.1.1.3	Implicit VR Little Endian	1.2.840.10008.1.2
		Explicit VR Little Endian	1.2.840.10008.1.2.1
		Explicit VR Big Endian	1.2.840.10008.1.2.2
		JPEG Baseline : Default Transfer Syntax for Lossy JPEG 8 Bit Image Compression	1.2.840.10008.1.2.4.50
		JPEG Lossless Compressed	1.2.840.10008.1.2.4.70

		JPEG Lossless Compressed	1.2.840.10008.1.2.4.70
		MPEG2 Main Profile @ Main Level	1.2.840.10008.1.2.4.100
Encapsulated PDF Storage	1.2.840.10008.5.1.4.1.1.104.1	Implicit VR Little Endian	1.2.840.10008.1.2
		Explicit VR Little Endian	1.2.840.10008.1.2.1
		Explicit VR Big Endian	1.2.840.10008.1.2.2
		JPEG Lossless Compressed	1.2.840.10008.1.2.4.70

Table 4.4: IODs, SOP Classes and Transfer Syntaxes for the Offline media

4.2.1.2.2 Activity – Export to USB

The Offline-Media Application Entity acts as an FSC when requested to export SOP Instances from the local database to USB medium. The medium characteristics are automatically detected by the system and shown to user. After user selection of patients, studies and images from the review list window, an exportation job is created by pressing the “USB” button. The contents of the export job will be written together with a corresponding DICOMDIR to the following filesystem hierarchy: at the root of the medium a folder named “Aixplorer” is created, in this folder will be created for each job a second folder whose name depends on date and time exportation job was created. Please note that this implementation does not follow the DICOM standard but allow user to create several DICOM media on one USB medium without mixing the contents of two different jobs.

Please refer to the user’s guide for configuration and use of DICOM Storage.

4.2.1.2.2.1 Media Storage Application Profiles

The Offline-Media Application Entity support the STD-GEN-USB-JPEG Application Profile.

4.2.1.2.2.2 Media Storage Application Profiles

The Offline-Media Application Entity supports the SOP Classes and Transfer Syntaxes listed in the Table 4.5 on the next page. Please note that when a Storage Application Profile is selected, the most adapted Transfer Syntaxes is selected for each IOD. At any time Transfer syntaxes can be forced to any value listed in Table 4.5 on the facing page. In such case, the created DICOM instances may not follow the Application profile. As a result, the DICOM instances will be present on the DICOM media, but won’t be referenced in the DICOMDIR.

Information Object Definition	SOP Class UID	Transfer Syntax UID	Transfer Syntax
-------------------------------	---------------	---------------------	-----------------

Ultrasound Image Storage	1.2.840.10008.5.1.4.1.1.6.1	Implicit VR Little Endian	1.2.840.10008.1.2
		Explicit VR Little Endian	1.2.840.10008.1.2.1
		Explicit VR Big Endian	1.2.840.10008.1.2.2
		JPEG Baseline : Default Transfer Syntax for Lossy JPEG 8 Bit Image Compression	1.2.840.10008.1.2.4.50
		JPEG Lossless Compressed	1.2.840.10008.1.2.4.70
Ultrasound Multi-Frame Image Storage	1.2.840.10008.5.1.4.1.1.3.1	Implicit VR Little Endian	1.2.840.10008.1.2
		Explicit VR Little Endian	1.2.840.10008.1.2.1
		Explicit VR Big Endian	1.2.840.10008.1.2.2
		JPEG Baseline : Default Transfer Syntax for Lossy JPEG 8 Bit Image Compression	1.2.840.10008.1.2.4.50
		JPEG Lossless Compressed	1.2.840.10008.1.2.4.70
		MPEG2 Main Profile @ Main Level	1.2.840.10008.1.2.4.100
(Retired) Ultrasound Image Storage	1.2.840.10008.5.1.4.1.1.6	Implicit VR Little Endian	1.2.840.10008.1.2
		Explicit VR Little Endian	1.2.840.10008.1.2.1
		Explicit VR Big Endian	1.2.840.10008.1.2.2
		JPEG Baseline : Default Transfer Syntax for Lossy JPEG 8 Bit Image Compression	1.2.840.10008.1.2.4.50
		JPEG Lossless Compressed	1.2.840.10008.1.2.4.70
(Retired) Ultrasound Multi-Frame Image Storage	1.2.840.10008.5.1.4.1.1.3	Implicit VR Little Endian	1.2.840.10008.1.2
		Explicit VR Little Endian	1.2.840.10008.1.2.1
		Explicit VR Big Endian	1.2.840.10008.1.2.2
		JPEG Baseline : Default Transfer Syntax for Lossy JPEG 8 Bit Image Compression	1.2.840.10008.1.2.4.50
		JPEG Lossless Compressed	1.2.840.10008.1.2.4.70
		MPEG2 Main Profile @ Main Level	1.2.840.10008.1.2.4.100
Encapsulated PDF Storage	1.2.840.10008.5.1.4.1.1.104.1	Implicit VR Little Endian	1.2.840.10008.1.2
		Explicit VR Little Endian	1.2.840.10008.1.2.1
		Explicit VR Big Endian	1.2.840.10008.1.2.2
		JPEG Lossless Compressed	1.2.840.10008.1.2.4.70

Table 4.5: IODs, SOP Classes and Transfer Syntaxes for the Offline media

4.3 Augmented and Private Application Profiles

Aixplorer does not support any augmented or private application profiles.

4.4 Media Configuration

The local applications use the AE Titles configured via the “System Configuration” → “Administration” → “Devices” tab of Aixplorer.

Please refer to the user’s guide for configuration and use of DICOM Storage.

Chapter 5

Support of Extended Character Sets

All Aixplorer DICOM applications support the following character set:
The character set has to be configured for each remote DICOM server.

DICOM	Character Set	Coverage
ISO_IR 6	ASCII	
ISO_IR 100	Latin alphabet #1	Afrikaans, Albanian, Breton, Catalan, Danish, English (UK and US), Faroese, Galician, German, Icelandic, Irish (new orthography), Italian, Kurdish (The Kurdish Unified Alphabet), Latin (basic classical orthography), Leonese, Luxembourgish (basic classical orthography), Norwegian (Bokmål and Nynorsk), Occitan, Portuguese (Portuguese and Brazilian), Rhaeto-Romanic, Scottish Gaelic, Spanish, Swahili, Swedish, Walloon, Basque
ISO_IR 101	Latin alphabet #2	Bosnian, Croatian, Czech, German, Hungarian, Polish, Romanian, Serbian (when in the Latin script), Slovak, Slovene, Upper Sorbian, and Lower Sorbian
ISO_IR 109	Latin alphabet #3	Turkish, Maltese and Esperanto
ISO_IR 110	Latin alphabet #4	Estonian, Latvian, Lithuanian, Greenlandic, and Sami
ISO_IR 144	Cyrillic	Bulgarian, Russian, Rusyn, Bosnian, Serbian, Macedonian, Ukrainian, Moldovan, Kazakh, Uzbek, Kyrgyz, Tajik, Tuvan, Mongolian
ISO_IR 127	Arabic	
ISO_IR 126	Greek	
ISO_IR 138	Hebrew	
ISO_IR 148	Latin alphabet #5	Turkish
ISO-2022-JP	Japanese	
GB18030	Chinese	
ISO_IR 192	Unicode	

Table 5.1: *Supported Character Set*

Chapter 6

Security

Aixplorer does not support any specific security measures. It is assumed that Aixplorer is used within a secured environment. It is assumed that a secured environment includes at a minimum:

1. Firewall or router protections to ensure that only approved external hosts have network access to Aixplorer.
2. Firewall or router protections to ensure that Aixplorer only has network access to approved external hosts and services.
3. Any communication with external hosts and services outside the locally secured environment use appropriate secure network channels (*e.g.* such as a Virtual Private Network (VPN)).

Other network security procedures such as automated intrusion detection may be appropriate in some environments. Additional security features may be established by the local security policy and are beyond the scope of this conformance statement.

Appendix

Appendix A

IOD contents

A.1 Created SOP instances

The following tables use a number of abbreviations. The abbreviations used in the “Presence of ...” column are:

- VNAP : Value Not Always Present (attribute sent zero length if no value is present);
- ANAP : Attribute Not Always Present;
- ALWAYS : Always Present;
- EMPTY: Attribute is sent without a value.

The abbreviations used in the “Source” column:

- USER : the attribute value source is from User input;
- MWL : the attribute value source is from DICOM Modality Worklist Service;
- AUTO : the attribute value is generated automatically;
- CONFIG : the attribute value source is a configurable parameter.

Note: All dates and times are encoded in the local configured calendar and time. Date, Time and Time zone are configured using the “System Configuration” → “System Display” → “Regional” tab.

A.1.1 US Image IOD Modules

See Table [A.1](#) on the next page.

IE	Module	Reference	Presence of Module
Patient	Patient	Table A.4 on page 98	ALWAYS
Study	General Study	Table A.5 on page 99	ALWAYS
	Patient Study	Table A.6 on page 99	ALWAYS
Series	General Series	Table A.7 on page 100	ALWAYS
Equipment	General Equipment	Table A.9 on page 101	ALWAYS
Image	General Image	Table A.12 on page 102	ALWAYS
	Image Pixel	Table A.13 on page 103	ALWAYS
	Contrast/bolus	Table A.14 on page 103	ANAP
	Device	Table A.11 on page 102	ANAP
	US Region Calibration	Table A.17 on page 104	ALWAYS
	US Image	Table A.18 on page 104	ALWAYS
	VOI LUT	Table A.19 on page 105	ANAP
Extended Attributes	SOP Common	Table A.21 on page 105	ALWAYS
	Private Application	Table B.1 on page 116	ANAP
	Extra Module	Table A.23 on page 107	ALWAYS

Table A.1: *US Image IOD Modules*

A.1.2 US Multi-Frame Image IOD Module

See table [A.2](#) on the next page.

A.1.3 Encapsulated PDF IOD Module

See table [A.3](#) on the facing page.

IE	Module	Reference	Presence of Module
Patient	Patient	Table A.4 on the following page	ALWAYS
Study	General Study	Table A.5 on page 99	ALWAYS
	Patient Study	Table A.6 on page 99	ALWAYS
Series	General Series	Table A.7 on page 100	ALWAYS
Equipment	General Equipment	Table A.9 on page 101	ALWAYS
Image	General Image	Table A.12 on page 102	ALWAYS
	Image Pixel	Table A.13 on page 103	ALWAYS
	Contrast/bolus	Table A.14 on page 103	ANAP
	Cine	Table A.15 on page 103	ALWAYS
	Multi-Frame	Table A.16 on page 103	ALWAYS
	Device	Table A.11 on page 102	ANAP
	US Region Calibration	Table A.17 on page 104	ALWAYS
	US Image	Table A.18 on page 104	ALWAYS
	VOI LUT	Table A.19 on page 105	ANAP
SOP Common	Table A.21 on page 105	ALWAYS	
Extended Attributes	Extra Module	Table A.23 on page 107	ALWAYS

Table A.2: *US Multi-Frame Image IOD Module*

IE	Module	Reference	Presence of Module
Patient	Patient	Table A.4 on the next page	ALWAYS
Study	General Study	Table A.5 on page 99	ALWAYS
	Patient Study	Table A.6 on page 99	ALWAYS
Series	Encapsulated Document Series	Table A.8 on page 101	ALWAYS
Equipment	General Equipment	Table A.9 on page 101	ALWAYS
	SC Equipment	Table A.20 on page 105	ALWAYS
Encapsulated Document	Encapsulated Document	Table A.22 on page 106	ALWAYS
	SOP Common	Table A.21 on page 105	ALWAYS
Extended Attributes	Extra Module	Table A.24 on page 108	ALWAYS

Table A.3: *Encapsulated PDF IOD Module*

A.1.4 Common Modules

Attribute Name	Tag	VR	Value	Presence of Value	Source
Patient's Name	(0010,0010)	PN	From Modality Worklist or user input. Values supplied via Modality Worklist will be entered as received.	VNAP	MWL/ USER
Patient ID	(0010,0020)	LO	From Modality Worklist or user input	VNAP	MWL/ USER
Issuer of Patient ID	(0010,0021)	LO	From Modality Worklist or empty	VNAP	MWL
Patient's Birth Date	(0010,0030)	DA	From Modality Worklist or user input	VNAP	MWL/ USER
Patient's Sex	(0010,0040)	CS	From Modality Worklist or user input	VNAP	MWL/ USER
Other Patient IDs	(0010,1000)	LO	From Modality Worklist	VNAP	MWL
Referenced Patient Sequence	(0008,1120)	SQ	From Modality Worklist	VNAP	MWL
Patient's Birth Time	(0010,0032)	TM	From Modality Worklist	VNAP	MWL
Other Patient ID	(0010,1000)	LO	From Modality Worklist	VNAP	MWL
Patient Comments	(0010,4000)	LT	From Modality Worklist or user input	VNAP	USER
Patient Identity Removed	(0012,0062)	CS	de-identification selected by user	VNAP	USER
De-identification Method	(0012,0063)	LO	de-identification selected by user	VNAP	USER
Ethnic Group	(0010,2160)	SH	From Modality Worklist	VNAP	MWL

Table A.4: Patient Module Attributes of created SOP Instances

Attribute Name	Tag	VR	Value	Presence of Value	Source
Study Instance UID	(0020,000D)	UI	From Modality Worklist or generated by the device.	ALWAYS	MWL/USER
Study Date	(0008,0020)	DA	<yyyymmdd>	ALWAYS	AUTO
Study Time	(0008,0030)	TM	<hhmm>	ALWAYS	AUTO
Referring Physician's Name	(0008,0090)	PN	From Modality Worklist or user input	VNAP	MWL/USER
Study ID	(0020,0010)	SH	Generated by the device	ALWAYS	MWL/AUTO
Accession Number	(0008,0050)	SH	From Modality Worklist or user input.	VNAP	AUTO
Study Description	(0008,1030)	LO	user input	VNAP	USER
Referenced Study Sequence	(0008,1110)	SQ	Generated by the device	VNAP	AUTO
Procedure Code Sequence	(0008,1032)	SQ	From Modality Worklist	VNAP	AUTO
Physician(s) of Record	(0008,1048)	PN	From Modality Worklist	VNAP	AUTO

Table A.5: General Study Module of created SOP Instances

Attribute Name	Tag	VR	Value	Presence of Value	Source
Patient's Age	(0010,1010)	AS	Generated from Patient's Birth Date	VNAP	AUTO
Patient's Size	(0010,1020)	DS	user input or from Modality Worklist	VNAP	USER/MWL
Patient's Weight	(0010,1030)	DS	user input or from Modality Worklist	VNAP	USER/MWL
Additional Patient's History	(0010,21B0)	LT	From Modality Worklist	VNAP	MWL
Admission ID	(0038,0010)	LO	From Modality Worklist	VNAP	USER

Table A.6: Patient Study Module of created SOP Instances

Attribute Name	Tag	VR	Value	Presence of Value	Source
Modality	(0008,0060)	CS	US	ALWAYS	AUTO
Series Instance UID	(0020,000E)	UI	Generated by device	ALWAYS	AUTO
Series Number	(0020,0011)	IS	Generated by device	ALWAYS	AUTO
Laterality	(0020,0060)	CS	Empty	ALWAYS	AUTO
Series Date	(0008,0021)	DA	<yyyymmdd>	ALWAYS	AUTO
Series Time	(0008,0031)	TM	<hhmm>	ALWAYS	AUTO
Series Description	(0008,103E)	LO	User input	VNAP	USER
Performing Physician's Name	(0008,1050)	PN	User input	VNAP	USER
Protocol Name	(0018,1030)	LO	Free Form	ALWAYS	AUTO
Operators' Name	(0008,1070)	PN	Copy from Performing Physician's Name (0008,1050)	VNAP	USER
Referenced Performed Procedure Step Sequence	(0008,1111)	SQ		ALWAYS	AUTO
Patient Position	(0018,5100)	CS	Empty	ALWAYS	AUTO
Request Attributes Sequence	(0040,0275)	SQ		ALWAYS	AUTO
>Requested Procedure ID	(0040,1001)	SH	From Modality Worklist	ALWAYS	AUTO
>Accession Number	(0008,0050)	SH	From Modality Worklist	ALWAYS	AUTO
>Scheduled Procedure Step ID	(0040,0009)	SH	From Modality Worklist	ALWAYS	AUTO
>Scheduled Procedure Step Description	(0040,0007)	LO	From Modality Worklist	ALWAYS	AUTO
>Scheduled Protocol Code Sequence	(0040,0008)	SQ	From Modality Worklist	ALWAYS	AUTO

Table A.7: General Series Module of created SOP Instances

Attribute Name	Tag	VR	Value	Presence of Value	Source
Modality	(0008,0060)	CS	set to US	ALWAYS	AUTO
Series Instance UID	(0020,000E)	UI	Generated by device	ALWAYS	AUTO
Series Number	(0020,0011)	IS	Generated by device	ALWAYS	AUTO
Laterality	(0020,0060)	CS	Empty	ALWAYS	AUTO
Series Date	(0008,0021)	DA	Generated by device	ALWAYS	AUTO
Series Time	(0008,0031)	TM	Generated by device	ALWAYS	AUTO
Performing Physicians' Name	(0008,1050)	PN	From Modality Worklist or User input	ANAP	MWL/USER
Series Description	(0008,103E)	LO	User input	VNAP	AUTO
Protocol Name	(0018,1030)	LO	set to Free Form	ALWAYS	AUTO
Operators' Name	(0008,1050)	PN	From Modality Worklist or User input	ANAP	MWL/USER
Patient Position	(0018,5100)	CS	empty	ALWAYS	AUTO

Table A.8: Encapsulated Document Series Module of created SOP Instances

Attribute Name	Tag	VR	Value	Presence of Value	Source
Manufacturer	(0008,0070)	LO	SuperSonic Imagine SA	ALWAYS	AUTO
Institution Name	(0008,0080)	LO	Configuration	ALWAYS	AUTO
Institution Address	(0008,0081)	ST	Configuration	ALWAYS	AUTO
Station Name	(0008,1010)	SH	Configuration	ALWAYS	AUTO
Manufacturer's Model Name	(0008,1090)	LO	Aixplorer	ALWAYS	AUTO
Device Serial Number	(0018,1000)	LO	Device Serial Number	ALWAYS	AUTO
Software Versions	(0018,1020)	LO	Software Versions	ALWAYS	AUTO

Table A.9: General Equipment Module of created SOP Instances

Attribute Name	Tag	VR	Value	Presence of Value	Source
Manufacturer	(0008,0070)	LO	SuperSonic Imagine SA	ALWAYS	AUTO
Manufacturer's Model Name	(0008,1090)	LO	Aixplorer	ALWAYS	AUTO
Device Serial Number	(0018,1000)	LO	Device Serial Number	ALWAYS	AUTO
Software Versions	(0018,1020)	LO	Software Versions	ALWAYS	AUTO

Table A.10: Enhanced General Equipment Module of created SOP Instances

Attribute Name	Tag	VR	Value	Presence of Value	Source
Manufacturer	(0008,0070)	LO	SuperSonic Imagine SA	ALWAYS	AUTO
Manufacturer's Model Name	(0008,1090)	LO	Aixplorer.	ALWAYS	AUTO
Device Serial Number	(0018,1000)	LO	Generated by device.	ALWAYS	AUTO

Table A.11: Device Module of created SOP Instances

Attribute Name	Tag	VR	Value	Presence of Value	Source
Instance Number	(0020,0013)	IS	Generated by the device	ALWAYS	AUTO
Patient Orientation	(0020,0020)	CS	Always empty.	EMPTY	AUTO
Content Date	(0008,0023)	DA	Generated by device	ALWAYS	AUTO
Content Time	(0008,0033)	TM	Generated by device	ALWAYS	AUTO
Image Type	(0008,0008)	CS	ORIGINAL, DERIVED, PRIMARY	ALWAYS	AUTO
Acquisition Number	(0020,0012)	IS	Generated by device	ALWAYS	AUTO
Acquisition Date	(0008,0022)	DA	Generated by device	ALWAYS	AUTO
Acquisition Time	(0008,0032)	TM	Generated by device	ALWAYS	AUTO
Acquisition DateTime	(0008,002A)	DT	Generated by device	ALWAYS	AUTO
Burned In Annotation	(0028,0301)	CS	Generated by device	ALWAYS	AUTO
Lossy Image Compression	(0028,2110)	CS	Generated by device	ANAP	AUTO
Lossy Image Compression Method	(0028,2114)	CS	Generated by device	ANAP	AUTO
Lossy Image Compression Ratio	(0028,2112)	CS	Generated by device	ANAP	AUTO

Table A.12: General Image Module of created SOP Instances

Attribute Name	Tag	VR	Value	Presence of Value	Source
Samples per Pixel	(0028,0002)	US	3	ALWAYS	AUTO
Photometric Interpretation	(0028,0004)	CS	RGB, YBR_FULL_422, MONOCHROME2	ALWAYS	AUTO
Rows	(0028,0010)	US	Configuration (max 1050)	ALWAYS	AUTO
Columns	(0028,0011)	US	Configuration (max 1400)	ALWAYS	AUTO
Pixel Aspect Ratio	(0028,0034)	US	1:1	ALWAYS	AUTO
Bits Allocated	(0028,0100)	US	8	ALWAYS	AUTO
Bits Stored	(0028,0101)	US	8	ALWAYS	AUTO
High Bit	(0028,0102)	US	7	ALWAYS	AUTO
Pixel Representation	(0028,0103)	US	0000H	ALWAYS	AUTO
Pixel Data	(7FE0,0010)	OW		ALWAYS	AUTO
Planar Configuration	(0028,0006)	US	0	ALWAYS	AUTO

Table A.13: Image Pixel Module of created SOP Instances

Attribute Name	Tag	VR	Value	Presence of Value	Source
Contrast/Bolus Agent	(0018,0010)	LO	Selected contrast agent	ANAP	AUTO

Table A.14: Contrast/Bolus Module of created SOP Instances

Attribute Name	Tag	VR	Value	Presence of Value	Source
Frame Time	(0018,1063)	DS	Only for US-MF image	ANAP	AUTO

Table A.15: Cine Module of created US Multi-frame SOP Instances

Attribute Name	Tag	VR	Value	Presence of Value	Source
Number of Frames	(0028,0008)	IS	Only for US-MF image	ANAP	AUTO
Frame Increment Pointer	(0028,0009)	AT	Only for US-MF image	ANAP	AUTO

Table A.16: Multi-Frame Module of created US Multi-frame SOP Instances

Attribute Name	Tag	VR	Value	Presence of Value	Source
Sequence of Ultrasound Regions	(0018,6011)	SQ		ANAP	AUTO
>Region Location Min x0	(0018,6018)	UL		ANAP	AUTO
>Region Location Min y0	(0018,601A)	UL		ANAP	AUTO
>Region Location Max x1	(0018,601C)	UL		ANAP	AUTO
>Region Location Max y1	(0018,601E)	UL		ANAP	AUTO
>Physical Units X Direction	(0018,6024)	US		ANAP	AUTO
>Physical Units Y Direction	(0018,6026)	US		ANAP	AUTO
>Physical Delta X	(0018,602C)	FD		ANAP	AUTO
>Physical Delta Y	(0018,602E)	FD		ANAP	AUTO
>Region Spatial Format	(0018,6012)	US		ANAP	AUTO
>Region Data Type	(0018,6014)	US		ANAP	AUTO
>Region Flags	(0018,6016)	UL		ANAP	AUTO

Table A.17: US Region Calibration Module of created SOP Instances

Attribute Name	Tag	VR	Value	Presence of Value	Source
Samples per Pixel	(0028,0002)	US	3	ALWAYS	AUTO
Photometric Interpretation	(0028,0004)	CS	RGB or YBR_FULL_422	ALWAYS	AUTO
Planar Configuration	(0028,0006)	US	0	ALWAYS	AUTO
Bits Allocated	(0028,0100)	US	8	ALWAYS	AUTO
Bits Stored	(0028,0101)	US	8	ALWAYS	AUTO
High Bit	(0028,0102)	US	7	ALWAYS	AUTO
Pixel Representation	(0028,0103)	US	0000H	ALWAYS	AUTO
Image Type	(0008,0008)	CS	ORIGINAL, DERIVED, PRIMARY	ALWAYS	AUTO
Lossy Image Compression	(0028,2110)	CS	Generated by device	ANAP	AUTO
Ultrasound Color Data Present	(0028,0014)	CS	Generated by device	ANAP	AUTO
Acquisition DateTime	(0008,002A)	DT		ALWAYS	AUTO

Table A.18: US Image Module of created SOP Instances

Attribute Name	Tag	VR	Value	Presence of Value	Source
Window Center	(0028,1050)	DS	Set to 127	ANAP	CONFIG
Window Width	(0028,1051)	DS	Set to 254	ANAP	CONFIG

Table A.19: *VOI LUT Module of created SOP Instances*

Attribute Name	Tag	VR	Value	Presence of Value	Source
Conversion Type	(0008,0064)	CS	SD	ALWAYS	AUTO
Modality	(0008,0060)	CS	US	ALWAYS	AUTO
Secondary Capture Device ID	(0018,1010)	LO	Device serial number	ALWAYS	AUTO
Secondary Capture Device Manufacturer	(0018,1016)	LO	SuperSonic Imagine SA	ALWAYS	AUTO
Secondary Capture Device Manufacturer's Model Name	(0018,1018)	LO	Aixplorer	ALWAYS	AUTO
Secondary Capture Device Software Versions	(0018,1018)	LO		ALWAYS	AUTO

Table A.20: *SC Equipment Module of created SOP Instances*

Attribute Name	Tag	VR	Value	Presence of Value	Source
Specific Character Set	(0008,0005)	CS	See table 5.1 on page 90	ALWAYS	AUTO
SOP Class UID	(0008,0016)	UI	Configuration (US-SF, US-MF, Retired US-SF, Retired US-MF, encapsulated PDF)	ALWAYS	AUTO
SOP Instance UID	(0008,0018)	UI		ALWAYS	AUTO
Instance Creator Date	(0008,0012)	DA		ALWAYS	AUTO
Instance Creator Time	(0008,0013)	TM		ALWAYS	AUTO
Instance Creator UID	(0008,0014)	UI		ALWAYS	AUTO
Instance Number	(0020,0013)	IS		ALWAYS	AUTO

Table A.21: *SOP Common Module of created SOP Instances*

Attribute Name	Tag	VR	Value	Presence of Value	Source
Instance Number	(0020,0013)	IS		ALWAYS	AUTO
Content Date	(0008,0023)	DA		ALWAYS	AUTO
Content Time	(0008,0033)	TM		ALWAYS	AUTO
Acquisition DateTime	(0008,002A)	DT		ALWAYS	AUTO
Burned In Annotation	(0028,0301)	CS		ALWAYS	AUTO

Table A.22: *Encapsulated Document Module of created SOP Instances*

A.1.5 Extra Modules

These attributes extend the standard US Image and US Multiframe Image IODs

Attribute Name	Tag	VR	Value	Presence of Value	Source
Requesting Physician	(0032,1032)	PN	From Modality Worklist	VNAP	MWL
Medical Alerts	(0010,2000)	LO	From Modality Worklist	VNAP	MWL
Allergies	(0010,2110)	LO	From Modality Worklist	VNAP	MWL
Pregnancy Status	(0010,21C0)	CS	From Modality Worklist	VNAP	MWL
Presentation Intent Type	(0008,0068)	CS		ALWAYS	AUTO
Last Menstrual Date	(0010,21d0)	DA	From Modality Worklist	VNAP	MWL
Requesting Service	(0032,1033)	LO	From Modality Worklist	VNAP	MWL
Special Needs	(0038,0050)	LO	From Modality Worklist	VNAP	MWL
Patient State	(0038,0500)	LO	From Modality Worklist	VNAP	MWL
Performed Location	(0040,0243)	SH	From Configuration	ALWAYS	AUTO
Acquisition Context Description	(0040,0556)	ST		ALWAYS	AUTO
Names Of Intended Recipients Of Results	(0040,1010)	PN	From Modality Worklist	VNAP	MWL
Reason For The Imaging Service Request	(0040,2001)	LO	From Modality Worklist	VNAP	MWL
Imaging Service Request Comments	(0040,2400)	LT	From Modality Worklist	VNAP	MWL
Confidentiality Constraint On Patient Data Description	(0040,3001)	LO	From Modality Worklist	VNAP	MWL
Placer Order number/imaging service request	(0040,2016)	LO	From Modality Worklist	VNAP	MWL

Table A.23: Extra Module of created SOP Instances

These attributes extend the standard Encapsulated PDF IOD.

Attribute Name	Tag	VR	Value	Presence of Value	Source
Requesting Physician	(0032,1032)	PN	From Modality Worklist	VNAP	MWL
Medical Alerts	(0010,2000)	LO	From Modality Worklist	VNAP	MWL
Allergies	(0010,2110)	LO	From Modality Worklist	VNAP	MWL
Pregnancy Status	(0010,21C0)	CS	From Modality Worklist	VNAP	MWL
Presentation Intent Type	(0008,0068)	CS		ALWAYS	AUTO
Last Menstrual Date	(0010,21d0)	DA	From Modality Worklist	VNAP	MWL
Requesting Service	(0032,1033)	LO	From Modality Worklist	VNAP	MWL
Special Needs	(0038,0050)	LO	From Modality Worklist	VNAP	MWL
Patient State	(0038,0500)	LO	From Modality Worklist	VNAP	MWL
Performed Location	(0040,0243)	SH	From Configuration	ALWAYS	AUTO
Acquisition Context Description	(0040,0556)	ST		ALWAYS	AUTO
Names Of Intended Recipients Of Results	(0040,1010)	PN	From Modality Worklist	VNAP	MWL
Reason For The Imaging Service Request	(0040,2001)	LO	From Modality Worklist	VNAP	MWL
Imaging Service Request Comments	(0040,2400)	LT	From Modality Worklist	VNAP	MWL
Confidentiality Constraint On Patient Data Description	(0040,3001)	LT	From Modality Worklist	VNAP	MWL
Placer Order number/imaging service request	(0040,2016)	LO	From Modality Worklist	VNAP	MWL
Series Date	(0008,0021)	DA	From Configuration	ALWAYS	AUTO
Acquisition Date	(0008,0022)	DA	From Configuration	ALWAYS	AUTO
Series Time	(0008,0031)	TM	From Configuration	ALWAYS	AUTO
Acquisition Time	(0008,0032)	TM	From Configuration	ALWAYS	AUTO
Performing Physician's Name	(0008,1050)	PN	User input	VNAP	AUTO
Operators' Name	(0008,1070)	PN	User input	VNAP	AUTO

Table A.24: Extra Module of created SOP Instances for Encapsulated PDF IOD

A.2 Used Fields in received IOD

Aixplorer storage application does not receive SOP instances. The usage of attributes received by Modality Worklist is described in section 3.2.2.3.1.3 on page 33.

A.3 Attribute Mapping

A.3.1 Worklist-Instances-MPPS IOD mapping

The relationships between attributes received via Modality Worklist, stored in acquired images and communicated via MPPS are summarized in Table A.25 on the following page. The format and conventions used are the same as the corresponding table in DICOM Part 4, Annex M.6 [DICOM].

Modality Worklist	Image IOD	MPPS IOD
Patient Name	Patient Name	Patient Name
Patient ID	Patient ID	Patient ID
Issuer Of Patient ID	Issuer Of Patient ID	Issuer Of Patient ID
Other Patient IDs	Other Patient IDs	Other Patient IDs
Patient's Birth Date	Patient's Birth Date	Patient's Birth Date
Patient's Sex	Patient's Sex	Patient's Sex
Referenced Patient Sequence	---	Referenced Patient Sequence
Admission ID	Admission ID	Admission ID
Patient's Weight	Patient's Weight	---
Referring Physician's Name	Referring Physician's Name	---
---	---	Scheduled Step Attributes Sequence
Study Instance UID	Study Instance UID	>Study Instance UID
Referenced Study Sequence	Referenced Study Sequence	>Referenced Study Sequence
Accession Number	Accession Number	>Accession Number
Placer Order Number / Imaging Service Request	---	> Placer Order Number / Imaging Service Request
---	Request Attributes Sequence	---
Requested Procedure ID	>Requested Procedure ID	>Requested Procedure ID
Requested Procedure Description	Requested Procedure Description	>Requested Procedure Description
Scheduled Procedure Step ID	>Scheduled Procedure Step ID	>Scheduled Procedure Step ID
Scheduled Procedure Step Description	>Scheduled Procedure Step Description	>Scheduled Procedure Step Description

Scheduled Protocol Code Sequence	>Scheduled Protocol Code Sequence	>Scheduled Protocol Code Sequence
---	Performed Protocol Code Sequence	Performed Protocol Code Sequence
---	Study ID	Study ID
---	Performed Procedure Step ID	Performed Procedure Step ID
---	Study Date	Performed Procedure Step Start Date
---	Study Time	Performed Procedure Step Start Time
---	Study Description	Performed Procedure Step Description
---	Study ID	Study ID
Comments on the Scheduled Procedure Step	Comments on the Performed Procedure Step	Comments on the Performed Procedure Step
---	---	Performed Series Sequence
Scheduled Performing Physician's Name	Performing Physician's Name	>Performing Physician's Name
Requested Procedure Code Sequence	Procedure Code Sequence	Procedure Code Sequence, Requested Procedure Code Sequence
---	Referenced Study Component Sequence	---
---	>Referenced SOP Class UID	SOP Class UID
---	>Referenced SOP Instance UID	SOP Instance UID
---	Protocol Name	Protocol Name

Table A.25: Attribute Mapping between Modality Worklist, Images and MPPS

A.3.2 Worklist attribute mapping in Aixplorer's user interface

The relationships between attributes received via Modality Worklist, fields displayed in Worklist and Patient Data window are summarized in Table A.26 on page 112.

Module Name Attribute Name	Tag	VR	VM	PDE	Worklist
SOP Common Specific Character Set	(0008,0005)	CS	1-n		
Scheduled Procedure Step Scheduled Procedure Step Sequence	(0040,0100)	SQ	1	Scheduled procedure Tab	
> Scheduled Station AET	(0040,0001)	AE	1-n	Station AET	

> Scheduled Procedure Step Start Date	(0040,0002)	DA	1	Step Start Date	Date
> Scheduled Procedure Step Start Time	(0040,0003)	TM	1	Step Start Time	Date
> Scheduled Procedure Step End Date	(0040,0004)	DA	1	Step End Date	
> Scheduled Procedure Step End Time	(0040,0005)	TM	1	Step End Time	
> Modality	(0008,0060)	CS	1		
> Scheduled Performing Physician's Name	(0040,0006)	PN	1	Sonographer	Performing Physician
> Scheduled Procedure Step Description	(0040,0007)	LO	1	Step Description	
> Scheduled Station Name	(0040,0010)	SH	1-n	Station Name	Scheduled Station Name
> Scheduled Procedure Step Location	(0040,0011)	SH	1	Location	Scheduled Station Location
> Scheduled Protocol Code Sequence	(0040,0008)	SQ	1	Scheduled Protocol Code Sequence	
> Pre-Medication	(0040,0012)	LO	1	Pre-Medication	
> Scheduled Procedure Step ID	(0040,0009)	SH	1	Step ID	
> Requested Contrast Agent	(0032,1070)	LO	1	Contrast Agent	
> Scheduled Procedure Step status	(0040,0020)	CS	1	Step status	
> Comments on the Scheduled Procedure Step	(0040,0400)	LT	1	Comments	
Requested Procedure					
Requested Procedure ID	(0040,1001)	SH	1	Requested ID	Exam
Requested Procedure Description	(0032,1060)	LO	1	Procedure Description	
Reason for the Requested Procedure	(0040,1002)	LO	1	Reason for Procedure	
Study Instance UID	(0020,000D)	UI	1	Study Instance UID	
Referenced Study Sequence	(0008,1110)	SQ	1	Referenced Study Sequence	
> Referenced SOP Class UID	(0008,1150)	UI	1	SOP Class UID	
> Referenced SOP Instance UID	(0008,1155)	UI	1	SOP Instance UID	
Requested Procedure Priority	(0040,1003)	SH	1		
Patient Transport Arrangements	(0040,1004)	LO	1		
Requested Procedure Code Sequence	(0032,1064)	SQ	1	Requested Procedure Code Sequence	
Names of intended recipients of results	(0040,1010)	PN	1-n	Recipients	
Requested Procedure Comments	(0040,1400)	LT	1	Comments	
Imaging Service Request					
Accession Number	(0008,0050)	SH	1	Accession #	Accession Number
Requesting Physician	(0032,1032)	PN	1	Requesting MD	
Referring Physician's Name	(0008,0090)	PN	1	Referring MD	
Requesting Service	(0032,1033)	LO	1	Requesting Service	
Reason for the Imaging Service Request (RET)	(0040,2001)	LO	1	Reason	
Imaging service request comments	(0040,2400)	LT	1	comments	
Placer Order number/imaging service request	(0040,2016)	LO	1		
Visit Identification					
Admission ID	(0038,0010)	LO	1	Admission ID	
Visit Status					
Current Patient Location	(0038,0300)	LO	1	Patient Location	
Visit Relationship					
Referenced Patient Sequence	(0008,1120)	SQ	1	Referenced Patient Sequence	
> Referenced SOP Class UID	(0008,1150)	UI	1	SOP Class UID	
> Referenced SOP Instance UID	(0008,1155)	UI	1	SOP Instance UID	
Patient Identification					
Patient Name	(0010,0010)	PN	1	Last Name, First Name, MI	Name
Patient ID	(0010,0020)	LO	1	Patient ID	Patient ID
Issuer of Patient ID	(0010,0021)	LO	1		
Other Patient IDs	(0010,1000)	LO	1-n	Other ID	
Patient Demographic					
Patient's Birth Date	(0010,0030)	DA	1	Date of Birth	Gender
Patient's Birth time	(0010,0032)	TM	1		
Patient's Sex	(0010,0040)	CS	1	Gender	
Patient's Weight	(0010,1030)	DS	1	Weight	

Patient's Size	(0010,1020)	DS	1	Height	
Confidentiality constraint on patient data	(0040,3001)	LO	1		
Patient comments	(0010,4000)	LT	1	Comments	
Ethnic Group	(0010,2160)	SH	1		
Patient Medical					
Patient State	(0038,0500)	LO	1	Patient State	
Pregnancy Status	(0010,21C0)	US	1	Pregnancy Status & Pregnant	
Medical Alerts	(0010,2000)	LO	1-n	Medical Alerts	
Allergies	(0010,2110)	LO	1-n	Allergies	
Special Needs	(0038,0050)	LO	1	Special Needs	
Additional patient History	(0010,21B0)	LT	1		
Last Menstrual Date	(0010,21D0)	DA	1	Last Menstrual Date& LMP& LMP	

Table A.26: Attribute Mapping between Modality Worklist, Worklist and Patient Data windows

A.4 Coerced/Modified Fields

The Modality Worklist AE will truncate attribute values received in the response to a Modality Worklist Query if the value length is longer than the maximum length permitted by the attribute's VR.

When the "Image De-Identification" option is enabled the attributes described in Table [A.27](#) on the facing page will be altered.

Attribute Name	Tag	De-Identification Method
Instance Creator UID	(0008,0014)	Not Present
SOP Instance UID	(0008,0018)	De-Identified value
Accession Number	(0008,0050)	De-Identified value
Institution Name	(0008,0080)	Not Present
Institution Address	(0008,0081)	Not Present
Referring Physician's Name	(0008,0090)	Not Present
Referring Physician's Address	(0008,0092)	Not Present
Station Name	(0008,1010)	Not Present
Study Description	(0008,1030)	Not Present
Series Description	(0008,103E)	Not Present
Performing Physicians' Name	(0008,1050)	Not Present
Operators' Name	(0008,1070)	Not Present
Referenced SOP Instance UID	(0008,1155)	Not Present
Patient's Name	(0010,0010)	Not Present
Patient ID	(0010,0020)	De-Identified value
Patient's Birth Date	(0010,0030)	Empty Value
Patient's Birth Time	(0010,0032)	Empty Value
Patient's Sex	(0010,0040)	Empty Value
Other Patient Ids	(0010,1000)	Empty Value
Patient's Age	(0010,1010)	Empty Value
Patient's Size	(0010,1020)	Not Present
Patient's Weight	(0010,1030)	Not Present
Ethnic Group	(0010,2160)	Not Present
Additional Patient's History	(0010,21B0)	Not Present
Patient Comments	(0010,4000)	Empty Value
Device Serial Number	(0018,1000)	Empty Value
Protocol Name	(0018,1030)	Empty Value
Study Instance UID	(0020,000D)	De-Identified value
Series Instance UID	(0020,000E)	De-Identified value
Study ID	(0020,0010)	Empty Value
Request Attributes Sequence	(0040,0275)	zero length
Issuer Of PatientID	(0010,0021)	Empty Value
Medical Alerts	(0010,2000)	Empty Value
Allergies	(0010,2110)	Empty Value
SpecialNeeds	(0038,0050)	Empty Value
PatientState	(0038,0500)	Empty Value
Performed Procedure Step Start Date	(0040,0244)	Empty Value
Performed Procedure Step Start Time	(0040,0245)	Empty Value
Performed Procedure Step Description	(0040,0254)	Empty Value
Placer Order number/imaging service request	(0040,2016)	Not Present

Table A.27: De-Identified attributes

Appendix B

Data Dictionary of Private Attributes

If appropriate options are set the AIXplorer may include private attributes in the US Image IODs. Private attributes are type 3, thus support for these attributes by receiving SCPs is not guaranteed. See Table [B.1](#) on the next page for more information.

Name	Description	Tag	VR	VM	Value
Contrast Quantification Private Creator	Private creator data element	(2FF1, 0060)	LO	1	Contrast Quantification
Contrast Quantification Version	Private Creator Data Version	(2FF1, 6001)	LO	1	1.0
Region Location Min X2	Location of the Contrast image (pixel coordinates)	(2FF1, 6018)	IS	1	
Region Location Min Y2	Location of the Contrast image (pixel coordinates)	(2FF1, 601A)	IS	1	
Region Location Min X3	Location of the Contrast image (pixel coordinates)	(2FF1, 601C)	IS	1	
Region Location Min Y3	Location of the Contrast image (pixel coordinates)	(2FF1, 601E)	IS	1	
Region Location Min X4	Location of the Contrast image (pixel coordinates)	(2FF1, 6019)	IS	1	
Region Location Min Y4	Location of the Contrast image (pixel coordinates)	(2FF1, 601B)	IS	1	
Region Location Min X5	Location of the B-Mode image (pixel coordinates)	(2FF1, 601D)	IS	1	
Region Location Min Y5	Location of the B-Mode image (pixel coordinates)	(2FF1, 601F)	IS	1	
Log-Compression Method	Method used for the Log-compression	(2FF1, 6031)	IS	1	
Anti-Log Law Vector / Coefficient Table	Inverse log-compression law for data linearization	(2FF1, 6032)	FL	256	
TGC Contrast Gain Vector	Unit: dB	(2FF1, 6032)	DS	256	
Palette Name		(2FF1, 6035)	LO	1	
Contrast Red Palette Data	Contrast palette RGB values	(2FF1, 6036)	IS	256	
Contrast Green Palette Data	Contrast palette RGB values	(2FF1, 6037)	IS	256	
Contrast Blue Palette Data	Contrast palette RGB values	(2FF1, 6038)	IS	256	
Transducer name		(2FF1, 6040)	LO	1	
SSI Q Private Creator	Private creator data element for header	(8FF1, 0013)	LO	1	SSI Rich Quantification Group
SSI Q Blob	Binary data	(8FF1, 1301)	OB	1	

Table B.1: *Data Dictionary of Private Attributes*

Appendix C

Private Transfer Syntaxes

No Private Transfer Syntaxes are supported.